

# MiniMed<sup>®</sup> 530G

## System User Guide



# Copyright & trademarks

©2012 Medtronic MiniMed, Inc. All rights reserved.

This product is covered by U.S. Patents. Other U.S. and/or foreign patents may be pending. Please visit <http://www.medtronicdiabetes.com/patents> for a listing of patents covering this product.

Bolus Wizard®, CareLink®, Dual Wave®, MiniMed®, MiniLink®, Quick-serter®, Quick-set®, and Square Wave® are registered trademarks of Medtronic MiniMed, Inc.

Easy Bolus™ and Enlite™ are trademarks of Medtronic MiniMed, Inc.

CONTOUR® is a registered trademark of Bayer.

Energizer® is a registered trademark of Eveready Battery Company.

Glucagon Emergency Kit® is a registered trademark of Eli Lilly and Company.



**Medtronic MiniMed**  
18000 Devonshire Street  
Northridge, CA 91325  
USA  
800 646 4633  
818 576 5555  
[www.medtronicdiabetes.com](http://www.medtronicdiabetes.com)

**R<sub>x</sub> Only**

6025813-012\_a

REF MMT-551 MMT-751

## Important Safety Information Regarding Your Insulin Pump (includes all models)

### Avoid Immersing Your Pump In Water

The pump was tested and met requirements for IPX7 at time of manufacture. For more information about IPX7, see the *Glossary* on *page 273*. Be aware that drops and bumps that occur over time will affect the integrity of the pump case and make it more vulnerable to damage from water. Lotions, sunscreens and insect repellent can also damage the pump case. It is not known how much water is needed to damage your pump. **You should avoid getting your pump wet. To shower, bathe, swim, or participate in water activities, always disconnect from your pump and reconnect after you are out of the water.**

If you inadvertently submerge your pump in water, dry the pump quickly using a soft, clean towel and verify that it is working properly by selecting **Selftest** from the pump's Utilities Menu. If you believe that water has entered your pump or you observe any other possible pump malfunction, please check your blood glucose, treat high blood glucose (if necessary) with an injection and contact our 24 Hour HelpLine at 1 800 646 4633 for further assistance. Symptoms of high blood glucose include fatigue, excessive thirst and nausea. Always contact your healthcare professional if you experience excessively high or low blood glucose levels, or if you have any questions about your care.

Important safety information is continued on the next page.

## Electrostatic Discharge

Although your pump is designed to be unaffected by typical levels of electrostatic discharge (ESD), very high levels of ESD can result in a reset of the pump's software with an associated pump error alarm. In most cases, exposure to high levels of ESD will trigger the pump's A-13 alarm although, under certain circumstances, high level ESD exposure can cause A-44, Bolus Stopped or Max Delivery alarms. High levels of ESD are more likely in situations where the relative humidity is very low, such as inside a heated building during the winter in areas where it is cold outside.

If your pump experiences an A-13 or other error alarm, press the **ESC** and **ACT** buttons to clear the alarm. If you are unable to clear the alarm by pressing **ESC** and **ACT**, you may need to remove and replace the pump's battery to clear the alarm. After clearing the alarm, you should always verify that your pump is set to the correct date and time and that all other settings (basal rate, max basal and bolus limits, etc.) are programmed to the desired values, since the software reset could erase your previously programmed settings. Please see *Alarms and alerts, on page 201* for more details regarding what to do if your pump displays an error alarm or other alert message.

*Please contact our 24 Hour HelpLine at 1 800 646 4633 to report any error alarms or other problems that occur with your pump.*

**WARNING: The Threshold Suspend feature will cause the pump to temporarily suspend insulin delivery for two hours when the sensor glucose reaches a set threshold. Under some conditions of use the pump can suspend again resulting in very limited insulin delivery. Prolonged suspension can increase the risk of serious hyperglycemia, ketosis, and ketoacidosis. Before using the Threshold Suspend feature, it is important to read the Threshold Suspend information in the Getting Started Guide and the MiniMed 530G System User Guide and discuss proper use of the Threshold Suspend feature with your healthcare provider.**

## Warranty

The expected life of the MiniMed insulin pump is a maximum of 4 years. Medtronic Diabetes warrants the MiniMed insulin pump against defects in materials and workmanship for a period of 4 years from the date of purchase.

During the warranty period, Medtronic Diabetes will, at its discretion, either repair or replace (with a new or recertified pump, at Medtronic Diabetes' discretion) any defective pump or motor, subject to the conditions and exclusions stated herein. In the event that a pump is repaired or replaced, the warranty period will not be extended.

This warranty is valid only if the MiniMed insulin pump is used in accordance with the manufacturer's instructions. This warranty will not apply:

- If damage results from changes or modifications made to the pump by the user or third persons after the date of manufacture.
- If damage results from use of non-Medtronic reservoirs and/or infusion sets.
- If damage results from service or repairs performed by any person or entity other than the manufacturer.
- If damage results from a *Force Majeure* or other event beyond the control of the manufacturer.
- If damage results from negligence or improper use, including but not limited to: improper storage, submersion in water or physical abuse, such as dropping or otherwise.

This warranty shall be personal to the original user. Any sale, rental or other transfer or use of the product covered by this warranty to or by a user other than the original user shall cause this warranty to immediately terminate. This warranty does not apply to batteries, infusion sets, reservoirs, and other accessories.

**The remedies provided for in this warranty are the exclusive remedies available for any breach hereof. Neither Medtronic Diabetes nor its suppliers or distributors shall be liable for any incidental, consequential, or special damage of any nature or kind caused by or arising out of a defect in the product.**

**All other warranties, expressed or implied, are excluded, including the warranties of merchantability and fitness for a particular purpose.**



# Contents

## ■ Introduction

- 3 Assistance
- 4 Emergency kit
- 5 Consumables
- 5 Accessories
- 6 How to wear your pump
- 7 Working with your healthcare professional
- 7 How to use this guide
- 8 User safety
- 8 Indications
- 9 Potential risks
- 12 Contraindications
- 12 General warnings
- 15 General precautions
- 16 Notice
- 16 Insulin pump and RF accessories
- 17 RF interference from other devices

## ■ The basics

- 21 Your pump
- 22 Practicing with your pump
- 23 Inserting the battery
- 25 Pump buttons

26	The pump screen
27	HOME screen
27	Screen icons
29	Scroll bar
29	Screen backlight
29	Beep/vibrate
29	Operating modes
30	Normal mode
30	Special mode
30	Attention mode
31	Menus
31	MAIN MENU
32	BOLUS MENU
32	SUSPEND (manual)
32	SENSOR MENU
32	CAPTURE EVENT
32	BASAL MENU
33	RESERVOIR + SET MENU
33	UTILITIES MENU
33	STATUS screen
34	If you remove your pump

## ■ Basic programming

37	Setting the time and date
39	Selecting the language
40	Bolus
41	Normal meal bolus using the exchange system
42	Bolus practice:
42	Normal meal bolus practice using exchanges
42	Normal meal bolus using carbohydrate counting
43	Normal meal bolus practice using carbohydrates
43	Meal bolus, correction bolus and insulin sensitivity



- 44 Practice: Meal bolus
- 44 Review your bolus deliveries
- 46 Maximum bolus limit
- 47 Example 1: Max bolus
- 47 Example 2: Max bolus
- 47 Scroll rate
- 48 Example: Scroll rate
- 48 BG Reminder
- 49 Capturing Events
- 54 Basal
- 54 Start and stop times
- 56 Your basal settings
- 57 Current basal delivery
- 57 Daily basal rate(s)
- 58 Setting the Max basal rate
- 59 Example 1: Max basal
- 59 Example 2: Max basal
- 59 Stopping your pump
- 60 Resume pump delivery
- 61 Example: Manual Suspend function
- 61 Practice: Manual Suspend function
- 61 Practice: Resume basal delivery after a manual Suspend

■ **Starting on insulin**

- 65 Prepare your pump for use
- 66 Setting up the reservoir
- 69 Changing your infusion set
- 77 Determining your pump settings

■ **Using the Bolus Wizard feature**

- 81 What is it?
- 81 Carbohydrate counting

81	Your blood glucose reading
81	Your personal Bolus Wizard feature settings
84	How the Bolus Wizard feature works
84	Bolus Wizard warnings
85	How to program the Bolus Wizard feature
90	About active insulin
91	Review your Bolus Wizard feature settings
91	Normal bolus using Bolus Wizard feature
93	Bolus Wizard feature examples
93	Example 1: Blood glucose on target (normal blood glucose) and no active insulin
94	Example 2: Blood glucose above target (high blood glucose) and no active insulin
95	Example 3: Blood glucose below target (low blood glucose) and no active insulin
95	Example 4: Blood glucose above target (high blood glucose) with active insulin
96	Example 5: Blood glucose below target (low blood glucose) with active insulin

## ■ **Optimizing pump therapy**

99	Square Wave and Dual Wave bolus
102	Square Wave bolus practice
102	Dual Wave bolus practice
103	Using the Bolus Wizard feature for a Square Wave or Dual Wave bolus
105	Easy bolus
107	Example 1: Easy bolus
108	Your turn: Easy bolus practice
108	Missed Bolus Reminder
110	Basal patterns
112	Example 1: Basal patterns
112	Example 2: Basal patterns

- 113 Your turn:
- 113 Temp basal rates
- 113 How does temp basal work?
- 113 Temp basal types

## ■ **Sensor features**

- 124 Setting up continuous glucose monitoring
- 124 About Threshold Suspend
- 124 How Threshold Suspend works
- 126 Threshold Suspend Examples
- 129 Charging the transmitter
- 129 Entering your sensor settings
- 141 Reviewing your settings
- 142 Inserting the Enlite sensor
- 142 Connecting the transmitter to the sensor
- 144 Preparing the sensor for communication
- 145 Calibrating the sensor
- 145 Entering meter BG for calibration

## ■ **Using your sensor**

- 151 Status screens
- 151 Reading the sensor glucose graphs
- 154 Opening and viewing the graphs
- 154 The graphs
- 155 Examples of continuous sensor glucose graphs
- 158 How to check for rapid changes in sensor glucose
- 158 The rapid change arrows
- 159 How to make glucose alerts silent
- 160 Calibration history
- 161 Sensor alert history
- 161 Using your system in water

## ■ Utilities

- 165 Alarm review
- 165 Setting your alert type
- 166 Auto-off
- 166 LOW RESV WARNING (Low reservoir warning)
- 167 Review daily insulin totals
- 168 Pump data management
- 168 Insulin delivery information
- 169 Sensor glucose information
- 170 Meter blood glucose information
- 175 Personal reminders
- 176 PC connect for change settings
- 176 Remote control option
- 177 Other Devices option
- 178 Block feature
- 178 Example: Block
- 179 Lock keypad feature
- 179 Selftest
- 180 User settings

## ■ Meter option

- 187 About meters

## ■ Therapy management software

- 193 CareLink® Personal
- 193 Reports
- 194 Logbook

## ■ Insulin pump therapy follow-up

- 197 Recommended follow-up
- 197 Everyday

197	Every month
198	Every three months
198	Laboratory tests
198	Every visit
198	Annually

## ■ Alarms and alerts

201	About alarms and alerts
202	Example:
202	Alarms
203	What to do
203	Alarm conditions
212	Alerts
213	What to do
213	Pump alert conditions
214	Sensor alert conditions

## ■ Troubleshooting

223	Troubleshooting pump issues
223	My pump has a NO DELIVERY alarm
224	What is a CHECK SETTINGS alarm?
224	What happens if I leave the pump battery out too long?
225	Why doesn't my pump battery last very long?
225	My screen appears distorted
226	The pump is asking me to rewind
226	My bolus stopped
226	My pump buttons are not acting right during a bolus
226	My pump will not display my blood glucose reading from my meter
227	I dropped my pump
227	I submerged my pump in water
228	I cannot get to the USER SETTINGS screen
228	Troubleshooting transmitter issues

- 228 Testing the transmitter
- 230 Troubleshooting sensor features
- 230 I want to reconnect an old sensor
- 230 I want to find a lost sensor
- 231 I disconnected my sensor during Threshold Suspend

## ■ **Maintenance**

- 235 Battery
- 235 Storage
- 236 Cleaning your pump
- 236 Cleaning the transmitter
- 236 Cleaning the Serter

## ■ **Pump specifications**

- 239 Alarms and error messages
- 239 Alarm history
- 239 Audio frequency
- 240 Backlight
- 240 Basal
- 240 BG Target
- 240 Bolus delivery
- 241 Maximum bolus
- 241 Bolus history
- 241 Bolus units
- 241 Bolus Wizard feature
- 241 Carb ratios
- 241 Carb units
- 241 Daily totals
- 241 Default screen
- 242 Delivery accuracy
- 242 Pump motor
- 242 Normal bolus

243	Dual Wave bolus
243	Easy bolus
243	Filling the infusion set
243	Infusion pressure
243	Insulin sensitivity
244	Low resv (reservoir) warning
244	Meter value
244	Occlusion detection
244	Percent temp basal
245	Power supply
245	Reservoir + Set history
245	Program safety checks
245	Charger size
245	Charger weight
245	Pump size
245	Pump weight
246	Remote control size
246	Remote control weight
246	Sensor size
246	Sensor weight
246	Serter size
246	Serter weight
246	Transmitter size
246	Transmitter weight
246	Remote control
247	Reservoir
247	Square Wave bolus
247	Temporary (temp) basal rate
247	Time and date screen
247	Environmental conditions
247	Radio frequency (RF) communication specifications
248	Quality of service

248	Data security
248	Status screen
250	Bolus Wizard feature specifications
252	Bolus Wizard feature examples
255	Insulin delivery default settings
257	Bolus Wizard feature default settings
257	Sensor features default settings
261	Guidance and manufacturer's declaration
269	Icon table

## ■ **Glossary**

## ■ **Index**



# 1



Introduction



# 1 Introduction

Thank you for choosing Medtronic Diabetes (legally known as Medtronic MiniMed, Inc.) as your partner in helping you gain better control of your diabetes. Whether you are beginning pump therapy for the first time or upgrading from a previous model, we believe that the combination of state-of-the-art technology and the simple, menu-driven programming of the pump will provide many benefits.

This user guide is designed to help you to understand insulin pump therapy, continuous glucose monitoring, and the operation of your MiniMed® 530G (MMT-551, MMT-751) system. Work closely with your healthcare professional for a safe and complete pump start.

## Assistance

Medtronic Diabetes provides a 24 Hour HelpLine for assistance. The HelpLine is staffed with representatives who are trained in the setup and operation of the pump and are able to answer pump-related questions. When calling the HelpLine or your local Medtronic Diabetes office, please have your pump and serial number available. The phone number for the 24 Hour HelpLine is also on the back of your pump.

Department	Telephone number
24 Hour HelpLine (calls within the United States)	800 646 4633
24 Hour HelpLine (calls outside the United States)	+1 818 576 5555
Web site	<a href="http://www.medtronicdiabetes.com">www.medtronicdiabetes.com</a>

## Emergency kit

Keep an emergency kit with you at all times to make sure that you always have necessary supplies. Inform a family member, co-worker, or friend where this emergency kit is kept. Please refer to the *User safety* section in this chapter for more information on pump safety. It is important that you test your blood glucose (BG) more frequently while you are traveling. The routine hassle of travel, including stress, changes in time zones, schedules and activity levels, meal times and types of food, can all affect your diabetes control. Be extra attentive to monitoring your BG frequently, and be prepared to respond if needed. Your emergency kit should include these items:

- Fast-acting glucose tablets
- Blood glucose monitoring supplies
- Urine ketone monitoring supplies
- Extra MiniMed infusion set and MiniMed reservoir
- Insulin syringe and fast-acting insulin (with dosage instructions from your healthcare professional)
- Wallet card
- Dressing and adhesive
- Glucagon Emergency Kit®
- Extra AAA alkaline batteries (Energizer® brand is recommended)



**WARNING: Do not use the Bolus Wizard to calculate a bolus for a period of time after giving a manual injection by syringe or pen. The Bolus Wizard does not account for manual injections, and could prompt you to deliver more insulin than needed. Too much insulin may cause hypoglycemia. Consult with your healthcare professional for how long you need to wait after a manual injection before you can rely on the active insulin calculation of your Bolus Wizard.**

## Consumables

The pumps use MiniMed disposable reservoirs and infusion sets for insulin delivery. Installation instructions for MiniMed reservoir and infusion sets are provided in the *Starting on insulin* chapter.

- **Reservoirs** — Only use Medtronic Diabetes custom-made reservoirs in the MiniMed 530G system. Look on the back of your pump for your model number. For the MMT-551 pump model, use the MMT-326A, 1.8 ml (180-unit) reservoir. The MMT-751 pump model can be used with either the MMT-332A, 3.0 ml (300-unit) reservoir or the MMT-326A, 1.8 ml (180-unit) reservoir, depending on your insulin needs.
- **Infusion sets** — Medtronic Diabetes provides a variety of infusion sets to fit your needs. Contact your healthcare professional for help in choosing an infusion set that fits your needs. Change your infusion set every two to three days per your infusion set manufacturer's instructions.



**WARNING: Only use reservoir and infusion sets manufactured by Medtronic Diabetes. The pump has undergone extensive testing to confirm appropriate operation when used with compatible reservoirs and infusion sets manufactured or distributed by Medtronic Diabetes. We cannot guarantee appropriate operation if the pump is used with reservoirs or infusion sets offered by third parties and therefore we are not responsible for any injury or malfunctioning of the pump that may occur in association with such use.**

## Accessories

- **Meter** — Your pump can be used with Bayer's CONTOUR® NEXT LINK Wireless Meter, a blood glucose meter powered by MWT1 technology. MWT1 is the wireless Radio Frequency (RF) technology that is used to transmit information from the meter to the pump. You can program your pump to automatically receive your BG reading from this meter. Bayer's CONTOUR® NEXT LINK Wireless Meter can also be used to upload insulin pump data to CareLink® Personal using a USB port on your computer. Refer to *Meter option, on*

*page 187* for setup instructions, and *page 146* for information on how to manually or wirelessly transmit blood glucose values from the meter to the pump.

- **Remote control** — The optional remote control (MMT-503) can be used with the pump to deliver normal boluses and manually suspend/resume the pump from a distant location. (This user guide provides programming instructions for the remote control. Refer to the remote control user guide for operating instructions.)
- **MiniLink® transmitter** — The transmitter (MMT-7703) is a small device that connects to the sensor. It comes with a tester (MMT-7706) and a charger (MMT-7705). When connected to a sensor that is inserted in the body, the transmitter automatically initializes the sensor and begins to periodically send glucose data to the pump using a radio signal.
- **Enlite™ sensor** — The sensor (MMT-7008) continuously converts tiny amounts of glucose from your fatty layer under the skin into an electronic signal. This signal is sent to the transmitter. Calibrate the sensor three to four times a day to improve accuracy.
- **CareLink USB upload device** — The CareLink USB (MMT-7305) is used to upload insulin pump data to the diabetes management software using a USB port on your computer.

To order supplies, call 800 646 4633, +1 818 362 5958 (outside U.S.), refer to the contacts list at the beginning of this user guide, or visit our web site at [www.medtronicdiabetes.com](http://www.medtronicdiabetes.com).

## How to wear your pump

There are different ways to wear your pump. Medtronic Diabetes has optional accessories that can hide, protect, and add to the convenience of wearing a pump. Refer to the website ([www.medtronicdiabetes.com/accessories](http://www.medtronicdiabetes.com/accessories)) for more information.

- **Holster** — To wear the pump on your belt.
- **Pump clip** — To wear the pump underneath your clothing.
- **Activity guard** — Children or people who are active in sports can use the guard to protect the pump from disconnecting.

- **Leather case** — Fine leather lined with nylon. Styling complements business and formal wear. Velcro flap provides easy access for programming. Wear it vertically with the built-in belt clip.

## Working with your healthcare professional

Always consult your healthcare professional about your diabetes management and insulin pump therapy. Your healthcare professional will prescribe the pump settings that are best for you. Always consult your healthcare professional before changing your pump settings or using advanced features.





This user guide contains some clinical language. Before using your pump and working with this user guide, consult your healthcare professional about how the clinical language in this guide applies to your diabetes management and insulin pump therapy.

## How to use this guide



**Note:** This user guide shows sample screens only. Your pump screens may be slightly different.

For step-by-step instructions, refer to the appropriate sections in this guide. Refer to the Glossary for definitions of terms and functions. The terms and symbols used in this guide are in the table below.

<b>Conventions:</b>	<b>Meaning:</b>
Press	to push and release the button
Hold	to push and keep pressure on the button
Select	to press  or  to highlight a screen item you want to select
Exit the menus	press <b>ESC</b> until the HOME screen appears
Pump buttons	always bold and uppercase; for example, <b>ESC, ACT</b>
Screen and menu names	always uppercase; for example, MAIN MENU, REWIND screen
Menu selections	always bold; for example, <b>24 Hour Setup, On, Off</b>
Flashing (blinking) screen item	you can change the value for that item with the  or  buttons
<b>NOTE and TIP</b>	additional helpful information

<b>Conventions:</b>	<b>Meaning:</b>
<b>Caution</b>	warns of a potential hazard which, if not avoided, may result in minor or moderate injury or damage to the equipment
<b>WARNING</b>	notifies you of a potential hazard which, if not avoided, could result in death or serious injury. It may also describe potential serious adverse reactions and safety hazards
Go to the...screen.	when a step instructs you to go to a certain screen, the path to that screen is shown. For example: Go to the ALARM MENU.  <b>Main &gt; Utilities &gt; Alarm</b>  <ol style="list-style-type: none"> <li>1. From the MAIN MENU, select <b>Utilities</b> and press <b>ACT</b>.</li> <li>2. In the UTILITIES MENU, select <b>Alarm</b> and press <b>ACT</b>.</li> <li>3. The ALARM MENU appears.</li> </ol>

## User safety

### Indications

#### MiniMed® 530G system

The MiniMed 530G System is intended for continuous delivery of basal insulin (at user selectable rates) and administration of insulin boluses (in user selectable amounts) for the management of diabetes mellitus in persons, sixteen years of age and older, requiring insulin as well as for the continuous monitoring and trending of glucose levels in the fluid under the skin. The MiniMed 530G System can be programmed to automatically suspend delivery of insulin for up to two hours when the sensor glucose value falls below a predefined threshold value.

The MiniMed 530G System consists of the following devices that can be used in combination or individually: MiniMed 530G Insulin Pump, Enlite™ Sensor, Enlite™ Serter, the MiniLink® Real-Time System, Bayer's CONTOUR® NEXT LINK Wireless Meter, CareLink® Pro Therapy Management Software for Diabetes, and CareLink® Personal Therapy Management Software for Diabetes. The system requires a prescription.



The MiniMed 530G System is not intended to be used directly for making therapy adjustments, but rather to provide an indication of when a finger stick may be required. All therapy adjustments should be based on measurements obtained using a home glucose monitor and not on values provided by the MiniMed 530G System.

The MiniMed 530G System is not intended to be used directly for preventing or treating hypoglycemia but to suspend insulin delivery when the user is unable to respond to the Threshold Suspend alarm to take measures to prevent or treat hypoglycemia themselves. Therapy to prevent or treat hypoglycemia should be administered according to the recommendations of the user's healthcare provider.

## Potential risks

### Risks related to insulin pump infusion

General risks related to insulin pump infusion set may include:

- Localized infection
- Skin irritation or redness
- Bruising
- Discomfort or pain
- Bleeding
- Irritation
- Rash

Patients should be instructed to follow the provided user guides for insertions and care of infusion sets. If an infusion site becomes irritated or inflamed, the infusion set should be removed and another placed in a new location.

### Risks related to insulin administration and pump use

Due to the use of insulin, there is risk related to the infusion of insulin and the potential interruptions of insulin delivery. These general risks may include:

- Hypoglycemia
- Hyperglycemia

### Risks related to the Threshold Suspend feature

General risks related to the Threshold Suspend feature may include:

- Your pump may not suspend even though your blood glucose is at or below the Suspend Threshold. This can cause hypoglycemia.
- Your pump may automatically suspend when your sensor glucose is at or below the Suspend Threshold, while your blood glucose is above that limit. This can cause hyperglycemia.

### **Risks related to sensor use**

#### **General risks related to sensor use may include:**

- Skin irritation or reaction to adhesives
- Bruising
- Discomfort
- Redness
- Bleeding
- Pain
- Rash
- Infection
- Irritation from tapes used with glucose-sensing products
- Raised bump
- Appearance of a small "freckle-like" dot where needle was inserted
- Allergic reaction
- Fainting secondary to needle insertion
- Soreness or tenderness
- Swelling at insertion site
- Sensor fracture, breakage or damage
- Minimal blood splatter associated with sensor needle removal
- Residual redness associated with adhesive and or tapes
- Scarring

#### **Specific risks related to sensor use**

During the conduct of the Performance Evaluation of the Enlite™ Glucose Sensor to Support a Full 144 Hours (6 Days) of Use<sup>1</sup>, the following specific sensor risks were identified:

- Pain at sensor insertion site during sensor wear (1 incident reported)
- Dermatological risks (number of events/number of skin assessments performed):
  - Redness due to device insertion (abdomen, 35/213)
  - Redness in area of adhesive (abdomen, 63/213)
  - Bruising (abdomen, 2/213)
  - Bump (induration) (abdomen, 1/213)
  - Bleeding:
    - Bleeding immediately after insertion (abdomen, 2/213)
    - Bleeding at removal (abdomen, 5/213)
  - Fluid discharge (abdomen, 1/213)
  - Other, including indentation from device, e.g., transmitter (abdomen, 9/213)

Taking medications with acetaminophen while wearing the sensor may falsely raise your sensor glucose readings. The level of inaccuracy depends on the amount of acetaminophen active in your body and may be different for each person. Always use BG meter readings to verify your glucose level before making therapy decisions.

The Enlite Sensor is not approved for use in children or adolescents aged younger than 16 years, pregnant women, or persons on dialysis.

It is not known how different conditions or medications common to the critically ill population may affect the performance of the system. Therefore, the use of this sensor in the critically ill population is not recommended.

Sensor placement and insertion is not approved for sites other than the belly (abdomen).

---

<sup>1</sup> Medtronic Inc., A Performance Evaluation of the Enlite™ Glucose Sensor to Support a Full 144 Hours (6 Days) of Use, CER247/Z25/C, May 2012.

## Risks related to Serter use

General risks with Serter use may include skin infection around the area where the serter is used.

## Risks related to the MiniMed 530G System

**General risks related to the MiniMed 530G System may include:**

- Hypoglycemia
- Hyperglycemia

### **Specific risks related to the MiniMed 530G System**

During the conduct of the In-Clinic, Randomized, Cross-Over Study to Assess the Efficacy of the Low Glucose Suspend (LGS) Feature in the MiniMed Paradigm® X54 System with Hypoglycemic Induction from Exercise <sup>2</sup>, the following specific system risks were identified:

- Bruising at sensor site (1 incident reported)
- Bleeding at sensor site (1 incident reported)
- Urine ketones resulting from improper connection of the tubing to the insulin pump (1 incident reported)

## Contraindications

Pump therapy is not recommended for people who are unwilling or unable to perform a minimum of four blood glucose tests per day.

Pump therapy is not recommended for people who are unwilling or unable to maintain contact with their healthcare professional.

Pump therapy is not recommended for people whose vision or hearing does not allow recognition of pump signals and alarms.

## General warnings

### Pump

The pump is not suitable for use in the presence of a flammable anaesthetic mixture with air, oxygen or nitrous oxide.

---

2 Medtronic Inc., An In-Clinic, Randomized, Cross-Over Study to Assess the Efficacy of the Low Glucose Suspend (LGS) Feature in the MiniMed Paradigm® X54 System with Hypoglycemic Induction from Exercise, CER235/Z25/A, November 2011.

Never rely on the pump beeps or vibrations alone to navigate through the pump screens or menus, as this may result in incorrect menu selection or setting. You should always check your pump if you hear any unanticipated beeps or vibrations. Do not rely on preset pump alarms or reminders alone to prompt you to check your blood glucose. Set additional reminders on other devices, such as your cell phone, to avoid forgetting to check your blood glucose.

The drive support cap should appear slightly indented at all times (as shown in the image). If you notice that the cap is loose, or sticking out, discontinue use of the pump and contact our 24 Hour Helpline at 1 800 646 4633 to arrange for your pump to be replaced. **Do not press on the drive support cap if it is sticking out. Pushing on the drive support cap may result in unintended delivery of insulin, which can cause hypoglycemia.**



### Reservoir and infusion sets

Only use reservoir and infusion sets manufactured by Medtronic Diabetes. The pump has undergone extensive testing to confirm appropriate operation when used with compatible reservoirs and infusion sets manufactured or distributed by Medtronic Diabetes. We cannot guarantee appropriate operation if the pump is used with reservoirs or infusion sets offered by third parties and therefore we are not responsible for any injury or malfunctioning of the pump that may occur in association with such use.

Do not put any other drugs/medications inside your reservoir to use with this pump. Only insulin that has been prescribed by your physician can be used in this pump.

## Tubing Connector

If insulin, or any liquid, gets inside the tubing connector, it can temporarily block the vents that allow the pump to properly prime the infusion set. This may result in the delivery of too little or too much insulin, which can cause hypoglycemia or hyperglycemia. To prevent liquid from getting inside the tubing connector, after you fill the reservoir make sure you hold the insulin vial upright when you remove the reservoir from the transfer guard. If you do not hold the insulin vial upright, insulin can get on the top of the reservoir and could transfer liquid into the tubing connector. If any liquid gets on the top of the reservoir or inside the tubing connector when you change your infusion set, start over with a new reservoir and infusion set. For instructions on setting up your reservoir, see *Setting up the reservoir*, on page 66. For instructions on changing your infusion set, see *Changing your infusion set*, on page 69.

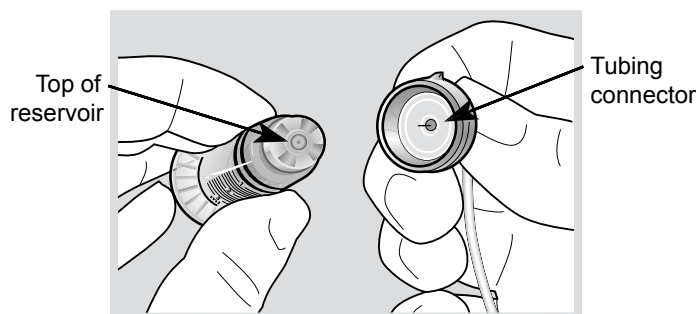

## Transmitter

Keep the transmitter away from children. This product contains small parts and may pose a choking hazard.

## Sensor

While there is no evidence of an Enlite sensor breaking in a patient's body, if you suspect that sensor breakage has occurred do not attempt to remove the sensor yourself. Contact your physician for assistance removing the sensor.

## Exposure to magnetic fields and radiation

If you are going to have an X-ray, MRI, diathermy treatment, CT scan, or other type of exposure to radiation, take off your pump, sensor, transmitter, meter and remote control before entering a room containing any of these equipment. The magnetic

fields and radiation in the immediate vicinity of these devices can make them non-functional or damage the part of the pump that regulates insulin delivery, possibly resulting in over delivery and severe hypoglycemia. If your pump is inadvertently exposed to a magnetic field, discontinue use and contact our 24 Hour Helpline for further assistance.

Do not use pump cases that have a magnetic clasp. Exposure to a magnetic clasp may interfere with the motor inside the pump.

### **Airport security**

Important information about airport security systems, and using your insulin pump on an airplane, can be found on the Emergency Card. Be sure to carry the Emergency Card provided when you are traveling.

### **General precautions**

#### **Avoid extreme temperatures**

Exposure to extreme temperatures can damage your device, which can adversely affect safety and effectiveness of your device. Avoid the following conditions:

1. Avoid exposing your pump and remote control to temperatures above 108°F (42°C) or below 34°F (1°C), as this may damage your device.
2. Insulin solutions freeze near 32°F (0°C) and degrade at high temperatures. If you are outside in cold weather, wear your pump close to your body and cover it with warm clothing. If you are in a warm environment, take measures to keep your pump and insulin cool.
3. Do not steam, sterilize or autoclave your pump or remote control. Exposure to high temperatures may damage your device.

#### **Infusion sets and sites**

Avoid using an infusion set insertion site that will be irritated by clothing and accessories, or by rigorous stretching and exercise.

#### **Sensor**

Prior to exercising, make sure the sensor is firmly attached, so it does not come out of your body.

Rotate the sensor insertion site so that sites do not become overused.

## Notice



**WARNING: Do not modify this product, as modification could result in a safety hazard.**

### Insulin pump and RF accessories

The pump, meter, transmitter and remote control comply with the United States Federal Communications Commission and international standards for electromagnetic compatibility.

These devices comply with Part 15 of the FCC Rules. Operation is subject to the following two conditions: (1) This device may not cause harmful interference, and (2) this device must accept any interference received, including interference that may cause undesirable operation. It does not interfere with any RF signals transmitted from outside sources.

These standards are designed to provide reasonable protection against excessive radio frequency interference and prevent undesirable operation of the device from unwanted electromagnetic interference. Operation is subject to the following two conditions:

1. This device has been tested and found to comply with the regulations governing such devices in your area. For the specific regulation and test results for your area, please contact our 24 Hour HelpLine.
2. This device generates, uses, and can radiate radio frequency energy and, if installed and used in accordance with the instruction, may cause harmful interference to radio communications. If the device does cause interference to radio or television reception, you are encouraged to try to correct the interference by one or more of the following measures:
  - Reorient or relocate the insulin pump/remote control/transmitter/meter
  - Increase the separation between the insulin pump/remote control/transmitter/meter and the device that is receiving/emitting interference

The meter and the transmitter send information to the pump using radio frequency. If other devices that use radio frequency are in use, such as cell phones, cordless phones and wireless networks, they may prevent



communication between the pump and the meter. This interference will not cause any incorrect data to be sent and will not cause any harm to your pump or meter. Moving away from or turning off these other devices may allow communication. Refer to *Troubleshooting*, on page 223 to correct interference problems you may have.

Wireless transmission between the pump and transmitter within the 6 feet (1.8 meters) operating range may be interrupted due to the transmitter orientation and the pump position on the body. Move the pump closer to the transmitter or to another position. If a Lost Sensor alarm has occurred retry:

**Main > Sensor > Link to Sensor > Find Lost Sensor**

If you have questions, please contact the 24 Hour HelpLine.

### RF interference from other devices

Common consumer electronic devices that transmit in the same frequency band used by the MMT-7703 MiniLink transmitter may prevent the pump from receiving the glucose information sent by the transmitter. Most cellular (mobile) phones and 900 MHz cordless phones, when transmitting or receiving, may cause significant interruption of transmitter-receiver communication. It is likely that other devices operating in similar frequency ranges will have a similar effect. This interference, however, will not cause any incorrect data to be sent and will not cause any harm to your transmitter.

The pump includes a programmable WEAK SIGNAL alert that notifies you when one or more expected transmissions were not received as expected by the pump. The pump will also issue a LOST SENSOR alert if communication is interrupted for an extended period of time. If you receive a LOST SENSOR alert, please see the *I want to find a lost sensor* section in the *Troubleshooting* chapter.

Communication problems can usually be resolved by:

- ensuring that there is less than 6 feet (1.8 meters) between the receiving device and transmitter, to include RF glucose meters;
- turning off or moving away from other RF transmitting devices; or
- reorienting or relocating the transmitter or receiving device, or both.

Communications problems may also occur due to cellular telephone interference. Testing conducted with several different cellular telephones indicates that, while a glucose value is being transmitted, using a cell phone within 12 inches (31 cm) of receiving devices, transmitters or RF glucose meters can interfere with reception of the transmitted values. In the event of such interference, normal communication can be re-established by:

- turning the cell phone off; or
- keeping the cell phone at least 12 inches (31 cm) away from the receiving device, transmitter or glucose meter when a glucose measurement is being transmitted.



**Tip:** If you are experiencing communication problems, try wearing your pump on one side of your body and the cell phone on the other. This normally resolves communication problems.

If you have questions, please contact the 24 Hour HelpLine.

# 2



the basics



# 2

## The basics

### Your pump

**Caution:** Do not use sharp objects to press the buttons on your pump. Using sharp objects can damage your pump.

Take a look at your pump. The reservoir window allows you to view the insulin in the reservoir. The reservoir, with the tubing connector attached, is inserted into the reservoir compartment of the pump.

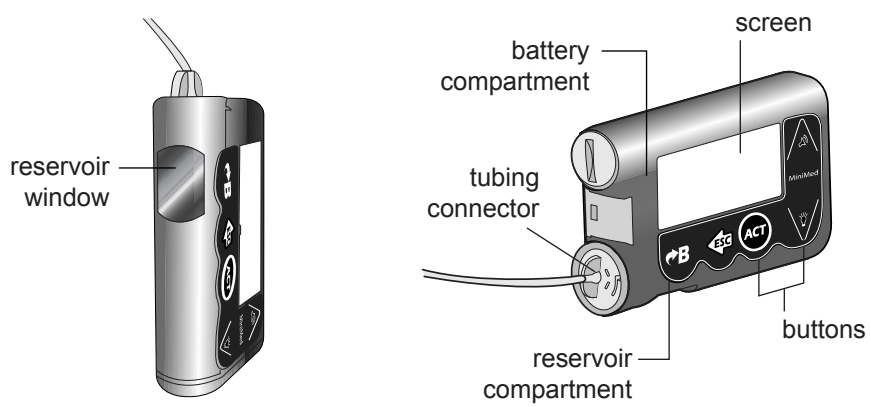

## Practicing with your pump

Your pump arrives from the factory in a mode that allows you to practice programming the pump without filling it with insulin. Do not select the **Rewind** or **Clear Settings** options in the pump menu as these will cancel the practice mode. If you accidentally select these functions, you will exit the practice mode. You will no longer be able to practice.

The **Rewind** option is only available from the Reservoir Setup menu. If you accidentally select **Reservoir Setup**, you can press **ESC** to exit the **Rewind** screen and cancel your selection. However, after you select **Rewind**, you must continue with the rewinding process. Refer to step 3 in the *Rewinding your pump* section.

If you accidentally select **Clear Settings**, you can press **ESC** or select **No** to exit the CONFIRM screen. However, after you select **Yes** to confirm, you must continue with the Clear Setting process. See *User settings, on page 180* for more information.



**WARNING:** Never start on insulin until directed by your healthcare professional. Do not use insulin in your pump while you are practicing by either inserting an insulin filled reservoir into your pump, or connecting an insulin filled infusion set to your body. Doing so could result in an infusion of insulin, not prescribed by your healthcare professional, which may cause low or high BG.



**Note:** If you are practicing, do not select the **Rewind** or **Clear Settings** options in the pump menu as these will cancel the practice mode. Make sure the red shipping cap is installed in the reservoir compartment as shipped.

## Inserting the battery



**Caution:** Do not remove the battery unless you are inserting a new battery. Insert the new battery within five minutes, or your pump will display the BATT OUT LIMIT or FAILED BATT TEST alarm and you may need to re-enter some pump settings. Follow the instructions in the message and make sure the time and date are set correctly.

Your pump accepts a **new** AAA alkaline battery, size E92, type LR03. As a safety measure, if you insert a battery that does not have full power, the WEAK BATTERY or FAILED BATT TEST alarm may sound. If you receive a WEAK BATTERY alarm, respond to the alarm and continue. The pump will suspend insulin delivery until you clear the alarm. After you clear the alarm, the pump will operate normally, with a decreased battery life.

### To insert a new battery:

1. Make sure all the following apply:
  - Clear (**ESC, ACT**) any alarms or alerts before removing and replacing the battery.
  - Make sure the pump is at the HOME (idle) screen when you remove the battery.
  - Do NOT remove the battery during a bolus or Fill Cannula delivery.
2. Use the edge of a coin to remove the battery cap. Turn the cap in a counter-clockwise direction.
3. Remove the old battery and dispose of it per the disposable requirements of your state or country. Put the new battery in the pump with the negative end [(-) symbol] going in first. Check the label on the back of the pump to make sure the battery is inserted correctly.

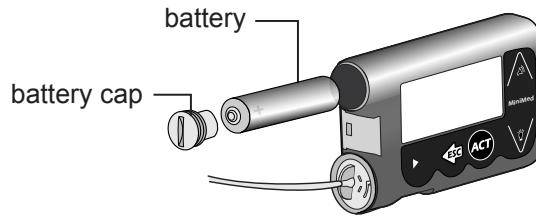

**Note:** Do not use cold batteries, as the battery life may incorrectly appear as low. Allow cold batteries to reach room temperature before you insert them in your pump.

4. Place the battery cap in the pump and tighten so the slot is aligned horizontally with the pump as shown here:

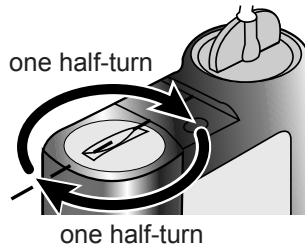

**Caution:** Do not over-tighten the battery cap. You should not turn the cap more than four half turns. If you over-tighten the cap you may not be able to remove it, and you can damage your pump.

5. While the pump turns on, it will show one or more screens until the HOME screen appears.  
If the HOME screen does not appear, do these steps:



HOME screen

- a. Check that the battery is inserted correctly. If the battery has been inserted backwards, remove the battery and insert it properly.





- b. If your pump still does not turn on or you get a FAILED BATT TEST alarm, remove and replace the battery with a new one.
- c. If the pump is still not on, call our 24 Hour HelpLine.
- 6. Check to make sure the time and date are correct. If more than five minutes have passed since you removed the battery, you will be prompted to check the time and date. Refer to the *Setting the time and date* section in the *Basic programming* chapter for programming instructions.
- 7. Press **ESC** to view the STATUS screen, making sure no alarms are active. If an alarm is active, follow the instructions on the screen.

## Pump buttons

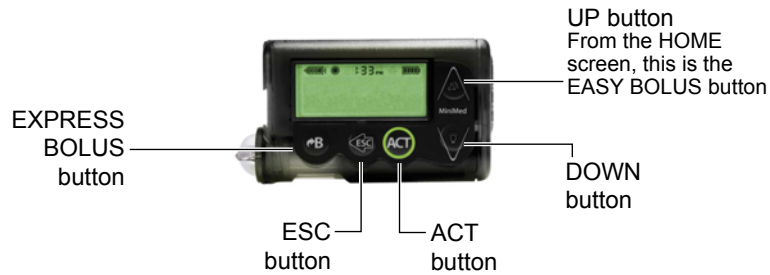
The buttons on the pump are used to navigate through the menus and screens, and to program the features of the pump.



The following table describes how to use the buttons on your pump **from the HOME screen**:

Button	Description
	<b>EASY BOLUS™</b> button – Shortcut to set and deliver an Easy Bolus.
	Turns the backlight on or off.
	Opens the MAIN MENU.

---

Button	Description
--------	-------------

---



- Opens the pump STATUS screen if the sensor feature is turned off.
  - Opens the following screens and graphs from the HOME screen if the sensor feature is turned on:
    - 1 press opens the last sensor graph selected.
    - 2 presses open the pump STATUS screen.
    - 3 presses open the SENSOR STATUS screen.
- 



**EXPRESS BOLUS** button – Shortcut to set any bolus.

---

The following table describes how to use the buttons on your pump **from the menus and programming screens**:

---

Button	Description
--------	-------------

---



Increases or decreases the value of a flashing item. Scrolls up or down the items in a list.

---



Accepts a selected menu item or activates a selected setting.

---



- Returns to previous screen or exits the menu.
  - Backs out of unintentional menu selections if the **ACT** button has not been pressed yet.
- 



- Press simultaneously with  to turn on backlight when in the menus.
  - Use as a Shift button by pressing it in combination with another button to access certain features.
- 

## The pump screen

The screen shows five lines of text at one time. The first is the operating mode. The second is the current open menu or function. The last three lines show either information or text that you can select for the current function.



**Note:** The screen text in the examples used in this guide might not exactly match the text on your pump screen. Please follow your pump screen instructions. If you have any questions, contact our 24 Hour HelpLine.

## HOME screen

The HOME screen serves as the starting point to access the programming screens. When no buttons are pressed for about 30 seconds, the pump returns to this screen.

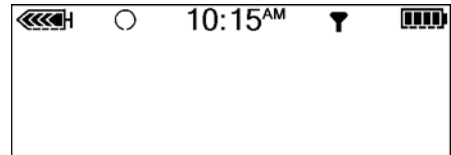

When you press **ACT** from the HOME screen, the MAIN MENU will appear.

When the pump is on, the following icons always appear across the top of the screen: reservoir volume icon, the time (12- or 24-hr), and the battery icon. If these do not appear, the pump is not operating.

## Screen icons

There are various icons that appear at the top of your pump screen, like the time, battery and reservoir icons mentioned above. The next sections describe what the icons mean.

## Battery

The battery icon tells you how much usable life is left in your battery. There are four segments in the icon. Each segment represents approximately 25 percent of the usable battery life you have left until you reach Low Battery point. So if you only have one segment left, make sure you have a new battery available.



## Time display

The current time of day is displayed across the top of the pump screen in the format you select—12-hour or 24-hour. The AM or PM is only displayed for the 12-hour format. For instructions on setting the time on your pump, see the *Setting the time and date* section in the *Basic programming* chapter.

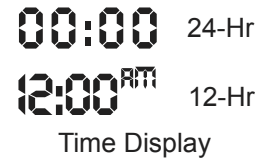

## Reservoir volume

The reservoir volume icon tells you how much insulin is in your pump. This icon is also divided into four segments. Each segment represents approximately 25 percent of the reservoir volume you have left. This allows you to be aware of how much insulin you have left in your pump. Refer to your STATUS screen to view the number of units left in the reservoir.

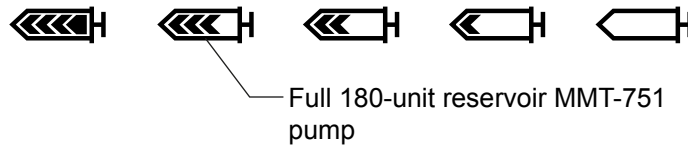

**Note:** For the MMT-751 pump model, your reservoir icon will only appear full if using a filled 300-unit reservoir. This icon will appear as indicated in the icon that is in the illustration above if you are using a 180-unit reservoir.

## Alert and alarm icons

An open circle (alert) or a solid circle (alarm) are displayed in the upper part of your pump screen only when there is an alert or alarm condition on your pump. For alarm and alert information, see *Alarms and alerts, on page 201*.

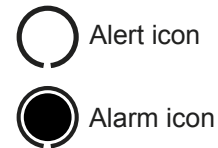

## Sensor icons

A dark sensor icon means that the sensor is on and the pump is receiving sensor data. A light-colored sensor icon with a dark circle around it means that the sensor is on, but the pump is not receiving sensor data. For information about the sensor, see the *Sensor features* chapter.

 Sensor is on and the pump is receiving sensor data



 Sensor is on but the pump is not receiving sensor data

## Scroll bar

If there is more text than the screen can show, a scroll bar appears on the right side of the screen. Press  to view any additional text.



## Screen backlight

When you press  from the HOME screen, the light on the screen turns on or off. During programming, the backlight can be turned on by pressing the  and the  together. The light will stay on while you are pressing any of the pump buttons. It will stay on as long as the current screen is active.

To conserve your battery, the backlight will turn off automatically while the pump is vibrating. After the vibration is finished, the light will turn back on. The backlight cannot be turned on in a low or dead battery condition.

## Beep/vibrate

Your pump will beep or vibrate to indicate activity. Refer to the *Setting your alert type* section in the *Utilities* chapter for setup instructions.

## Operating modes

The screen lets you know when a special feature is active or if there is a condition that needs your attention. The active features and pump status will determine the operating mode. The screens for the three modes are shown in the following sections.

## Normal mode

Mode for standard pump operations for normal basal and bolus delivery. No special features are active (such as basal patterns, temp basal, and others). No alarms and no alerts exist.

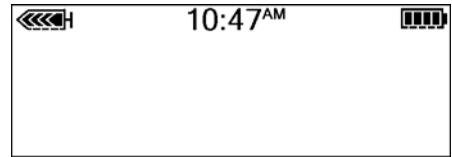

## Special mode

Indicates a special feature is active or an alert condition(s) exists. Special mode does not restrict any of the pump functions. When the pump is in Special mode, an open circle appears at the top of the screen and it beeps or vibrates periodically to remind you of the condition. The conditions and features that put the pump in Special mode are:

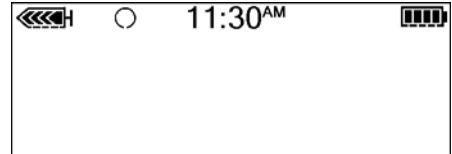

- Low Reservoir condition
- Low Battery condition
- Block feature is on
- Dual or Square Wave bolus delivery
- Basal pattern A or B is active
- Sensor alerts
- Temporary basal delivery
- Alert Silence is active

## Attention mode



**WARNING: Do not ignore your pump when it is in Attention mode because all insulin delivery is stopped, which may lead to high blood glucose and ketoacidosis.**

Attention mode indicates that insulin delivery has stopped. This can mean that the pump was manually suspended, or the pump automatically suspended insulin delivery due to an alarm condition.

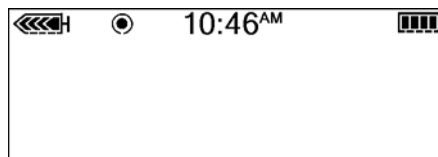



If an alarm is active or an alarm condition exists, immediate attention is required before insulin delivery resumes. A solid circle appears at the top of the screen and the pump will beep periodically until either the pump is taken out of Suspend mode or the condition is cleared. The screen will show text describing the condition that put the pump in Attention mode. For example, if the pump detects a blockage or the reservoir is empty, the NO DELIVERY alarm displays. Another example is when your sensor glucose value reaches or falls below the Suspend Threshold that you set, the THRESH SUSPEND alarm displays.

When the pump is in Attention mode, it will beep or vibrate periodically to remind you of the condition. The beep or vibrate frequency varies depending on the condition that put the pump in Attention mode. If the vibrate mode is on or off and your pump triggers the THRESHOLD SUSPEND alarm, it immediately begins to siren, to get your attention. Refer to the *Alarm conditions* section in the *Alarms and alerts* chapter for alarm conditions that will trigger the Attention mode. See the *Stopping your pump* section in the *Basic programming* chapter to learn how to manually suspend your pump.

## Menus

The MAIN MENU is the highest level menu. There are submenus, functions, status and programming screens in the lower menu levels. The menus are described in the following paragraphs.



**Tip:** If a screen item is flashing (blinking), during programming, press  or  to change the value.

## MAIN MENU

Highest menu level in the menu system. When you press **ACT** from the HOME screen, the MAIN MENU will appear.

## BOLUS MENU

Contains the settings and functions for bolus deliveries. The  button allows direct access to MANUAL BOLUS or to the BOLUS WIZARD feature without having to navigate through the menus. Refer to the *Basic programming* chapter for the manual bolus information or to the *Using the Bolus Wizard feature* chapter for bolusing using the Bolus Wizard feature.

## SUSPEND (manual)

Manually stops all current insulin deliveries until manually restarted by the user. Refer to the *Stopping your pump* section in the *Basic programming* chapter for more information.



**Note:** There is another Suspend feature called Threshold Suspend that is available when you are using continuous glucose monitoring.

## SENSOR MENU

Contains the functions to setup the interface between the sensor and the pump and access to the pump's sensor features.

## CAPTURE EVENT

Contains the options you use to enter information about different events into the system. Examples of events include: the amount of insulin used for injections, and the carbohydrates consumed during meals or snacks. The Capture Event option appears in the MAIN MENU after this feature has been turned on in the UTILITIES MENU. See the *Capturing Events* section in the *Basic programming* chapter for more details.

## BASAL MENU

Contains the functions to setup and deliver your basal. Refer to the *Basal* section in the *Basic programming* chapter for more information.



## RESERVOIR + SET MENU

Contains the functions required to change your reservoir and fill the infusion set with insulin. Refer to *Changing your infusion set* section in the *Starting on insulin* chapter for more information.

## UTILITIES MENU



Contains features for your safety and convenience. Refer to the *Utilities* chapter for more information.

## STATUS screen

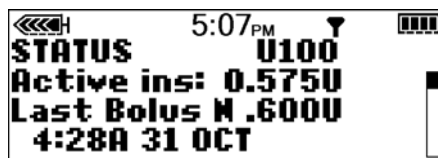
The STATUS screen shows information about what your pump is doing. Only check your pump status (press **ESC**) when you are not programming your pump. If you press **ESC** during programming, you will cancel the settings you are trying to enter.



The information that shows on the STATUS screen depends on the current activities and conditions of your pump.

- To open the STATUS screen, press **ESC** until the STATUS screen appears.
- To view more text on STATUS screen, press  or  to scroll and view all of the information.
- To exit the STATUS screen, press **ESC** until the STATUS screen disappears.

The screen includes information about:

- Last bolus insulin delivery
- Current basal insulin delivery
- The amount of active insulin, if any
- Special features that are turned on
- Last alarm/alert that was cleared within 24 hours
- Most recent BG meter reading received within 24 hours
- Reservoir status
- Battery status

- Time and date

Refer to the *Pump specifications* chapter for a complete list of the information that is available in the STATUS screen.

## If you remove your pump

You may have an occasion when you need or want to remove your pump. If you have to remove and store your pump, it is recommended that you do the following:

- Store your pump with the battery in place
- Keep a record of your current basal rates and use the *Save Settings* feature (see the *Saving the settings* section in the *Utilities* chapter).
- To preserve battery life, reset the basal rates to 0 (zero), turn off the remote and meter options, and set Auto-off to dashes or zeroes.

**Remember, your body still needs insulin while your pump is removed.**

Consult your healthcare professional for the insulin adjustments needed when you disconnect from your pump. Disconnecting from your pump for less than one hour may not require an insulin adjustment. If you remove your pump for more than one hour, take your insulin another way, as prescribed by your healthcare professional.

# 3



# 3 Basic programming

## Setting the time and date

Setting the correct time and date in your pump is necessary for accurate basal insulin delivery and allows you to keep an accurate record of your insulin delivery and other pump functions. You can select a 12-hour or 24-hour clock. You must reset the time and date if you receive a CHECK SETTINGS alarm or you clear your settings (Clear Settings function).

### To set the time and date:

1. Go to the TIME/DATE SETUP screen.

Main > Utilities > Time/Date



2. Select 12 Hour Setup or 24 Hour Setup and press ACT.

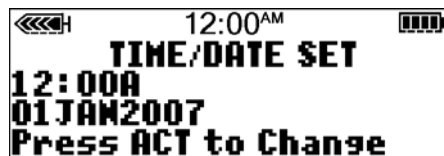

3. Press ACT again to change the settings.
4. Change each of the settings as follows:
  - a. Hour

Change the hour. Press **ACT**.

For 12-hour setups, press  or  until the correct A (am) or P (pm) appears.



b. Minutes

Change the minutes. Press **ACT**.



c. Year

Change the year. Press **ACT**.

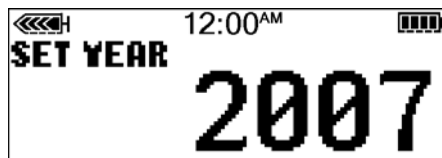

d. Month

Change the month. Press **ACT**.

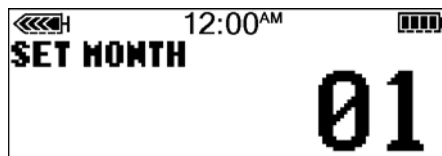

e. Day

Change the day. Press ACT.

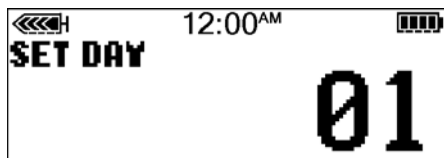

5. The TIME SET AT screen will show the settings that you programmed. Press ACT and exit the menus.

Your time/date settings are complete.

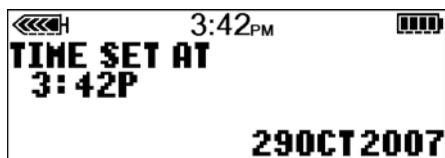

## Selecting the language

The language shown on the pump screens can be changed. Some languages may not be available on all pumps. Before you can select another language, you need to set the time using the English screens. Refer to the previous section.

### To change the language for your pump:

1. Go to the LANGUAGE MENU screen.

Main > Utilities > Language



2. Select your language, then press ACT.

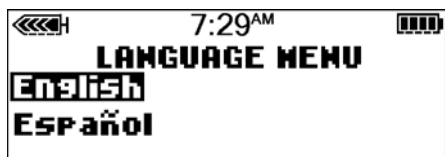

3. The language setting is now changed. Exit the menus.

## Bolus

There are three bolus types: Normal, Square Wave®, and Dual Wave®. This section gives instructions for a Normal bolus using the **EXPRESS BOLUS** button and navigating through the menus. (For information about Square Wave and Dual Wave boluses, refer to the *Optimizing pump therapy* chapter.)

The Normal bolus delivers an immediate food or correction bolus. It can be delivered at any time except during another Normal bolus. During a Normal bolus, most pump features are disabled until after all the bolus has been delivered. The manual **Suspend** function and the STATUS screen, however, are always available.

### Setting the Normal bolus

Normal bolus can be used to cover the carbohydrate in a meal or snack or to correct a blood glucose that is higher than your blood glucose target.

**The following instructions are for a Normal bolus when the Bolus Wizard feature is turned off.**

#### To set the Normal bolus:

1. Go to the BOLUS MENU.

Main > Bolus

Select **Set Bolus** and press **ACT**. Go to step 2.

You can also use the **EXPRESS BOLUS** button to get to step 2. Press **EXPRESS BOLUS** from your HOME screen.

2.
  - a. **If the SET BOLUS screen appears:** (Dual/Square option is off) Go to step 3.
  - b. **If the BOLUS TYPE screen appears:** (Dual/Square Wave is on) Select **Normal Bolus** and press **ACT**. Go to step 3.
3. The SET BOLUS screen (or SET NORMAL BOLUS screen if the Dual/Square option is on) appears with 0.0 unit bolus amount flashing. Enter your bolus amount and press **ACT**.

If some of the bolus insulin delivered by the pump has not been used and is active in your body, the screen will show this amount as Act. Ins. (Active Insulin). This amount is based on the active insulin setting selected in the



Bolus Wizard feature. The Active Insulin amount shows even if the Bolus Wizard feature is turned off. Take this amount into consideration to determine your bolus. See *About active insulin*, on page 90 for more information.



**Note:** If you have BG Reminder turned On, the BG REMINDER DURATION screen displays. It allows you to set the duration before you are reminded to check your blood glucose after a bolus. See the *BG Reminder* section in this chapter for information about this feature.

- The BOLUS DELIVERY screen appears and the Normal bolus starts. The pump will beep/vibrate at the start of the bolus. As the bolus delivers, the amount shown on the screen will increase until the entire bolus has been delivered. When the bolus is finished, the pump will beep/vibrate again and the HOME screen will appear.

The following practice lessons will help you understand this pump feature.

### Normal meal bolus using the exchange system

Normal bolus can be used to cover the carbohydrate in a meal or snack and to correct a blood glucose that is higher than the target that was chosen for you.

Fred has been taught that he needs to take 1 unit of insulin for every carbohydrate exchange that he eats (every milk, every starch or every fruit). For lunch today he will eat:

Turkey sandwich with two slices of bread	2 starches
1 small apple	1 fruit
1 cup of non-fat milk	1 milk

---

**Total carbohydrate exchanges = 4**

Fred's lunch has a total of 4 carbohydrate exchanges so he will take a meal bolus of 4 units for his lunch.

## Bolus practice:



**WARNING:** Never start on insulin until directed by your healthcare professional. Do not use insulin in your pump while you are practicing by either inserting an insulin filled reservoir into your pump, or connecting an insulin filled infusion set to your body. Doing so could result in an infusion of insulin, not prescribed by your healthcare professional, which may cause low or high BG.

Going through the menus, program a 2.0 unit Normal bolus now.

Check here if you were able to program it.

Using the **EXPRESS BOLUS** button , program a 2.0 unit Normal bolus now.

Check here if you were able to program it.

## Normal meal bolus practice using exchanges

Choose a meal you might eat and fill in the blanks.

Food: \_\_\_\_\_

\_\_\_\_\_

\_\_\_\_\_

exchange: \_\_\_\_\_

exchange: \_\_\_\_\_

exchange: \_\_\_\_\_

total exchanges: \_\_\_\_\_

You will take \_\_\_\_\_ units of insulin for each exchange. Your total bolus is \_\_\_\_\_ for this meal.

## Normal meal bolus using carbohydrate counting

Lydia has been taught that she needs to take 1 unit of insulin for every 10 grams of carbohydrate. This is her insulin to carbohydrate ratio. For dinner she will have:

4 oz. broiled chicken	0 grams
2/3 cup of rice	30 grams
1/2 cup cooked broccoli	5 grams
1 oz. dinner roll	15 grams
1 tsp margarine	0 grams

---

$$\text{total grams of carbohydrates} = 50 \text{ grams}$$

Lydia's dinner totals 50 grams of carbohydrate. Her insulin to carbohydrate ratio is 1 unit to 10 grams. She will take a meal bolus of 5 units for her dinner. She determined this by dividing 50 (total grams of carbohydrate) by 10 (insulin to carbohydrate ratio).

### Normal meal bolus practice using carbohydrates

Choose a meal you might eat and fill in the blanks.

Food: _____	grams of carbohydrate: _____
_____	grams of carbohydrate: _____
_____	grams of carbohydrate: _____
	<b>total grams of carbohydrate: _____</b>

Your insulin to carbohydrate ratio: 1 unit of insulin for \_\_\_\_\_ grams carbohydrate.

Divide your total carbohydrates by your insulin to carbohydrate ratio and take \_\_\_\_\_ units of insulin for your meal.

### Meal bolus, correction bolus and insulin sensitivity

Jason is ready to eat his breakfast. He has calculated that he will need 4.0 units for his food.

He tests his blood glucose and finds that it is 200 mg/dL. Jason knows that his blood glucose level is above his blood glucose target and will need additional insulin before he eats.

**Jason's healthcare professional has determined the following for him:**

BG Target: 110 mg/dL

Insulin sensitivity<sup>1</sup>: 36 mg/dL/u

---

<sup>1</sup> Insulin sensitivity is the amount (in mg/dL) by which blood glucose will be lowered after taking 1 unit of insulin. Consult with your healthcare professional to determine your insulin sensitivity.

Jason determines that he will need a correction bolus of 2.5 units insulin to lower his elevated blood glucose. The 2.5 correction bolus will lower his current blood glucose of 200 mg/dL to his target of 110 mg/dL.

- elevated blood glucose:  $200 - 110 = 90$  mg/dL
- correction bolus:  $90 / 36$  mg/dL/u (insulin sensitivity) = 2.5 units

(He will add this 2.5 correction bolus to the 4.0 units of insulin that he will need for his meal bolus. Jason will take a total bolus of 6.5 units.)

### Practice: Meal bolus

You have determined your meal bolus as: \_\_\_\_\_ units.

Your target blood glucose range is: \_\_\_\_\_ to \_\_\_\_\_ (average is \_\_\_\_\_).

Your current blood glucose level is: \_\_\_\_\_.

Your correction factor is: 1 unit of insulin will drop your blood glucose \_\_\_\_\_.

You will take \_\_\_\_\_ unit(s) of insulin to correct your high blood glucose level.

Your total bolus (meal bolus plus correction bolus) is \_\_\_\_\_.

### Review your bolus deliveries

You can view a list of your bolus deliveries in the BOLUS HISTORY screen. This screen shows a list of the dates, times, units, and types for your last 24 boluses. This feature is helpful for record keeping or to check if you bolused for your last meal.

If a bolus was stopped before delivery was complete, the BOLUS HISTORY screen will show only the amount actually delivered. Refer to the *Bolus details* section in this chapter for instructions about viewing bolus details.

#### Do the following steps to view the BOLUS HISTORY screen:

1. Go to the BOLUS HISTORY screen and scroll through the bolus deliveries.

##### Main > Bolus > Bolus History

If you used the Bolus Wizard feature to deliver any of these boluses, the BOLUS HISTORY screen shows the carbohydrate/food (CH) and blood glucose values that the Bolus Wizard feature used to calculate the boluses.

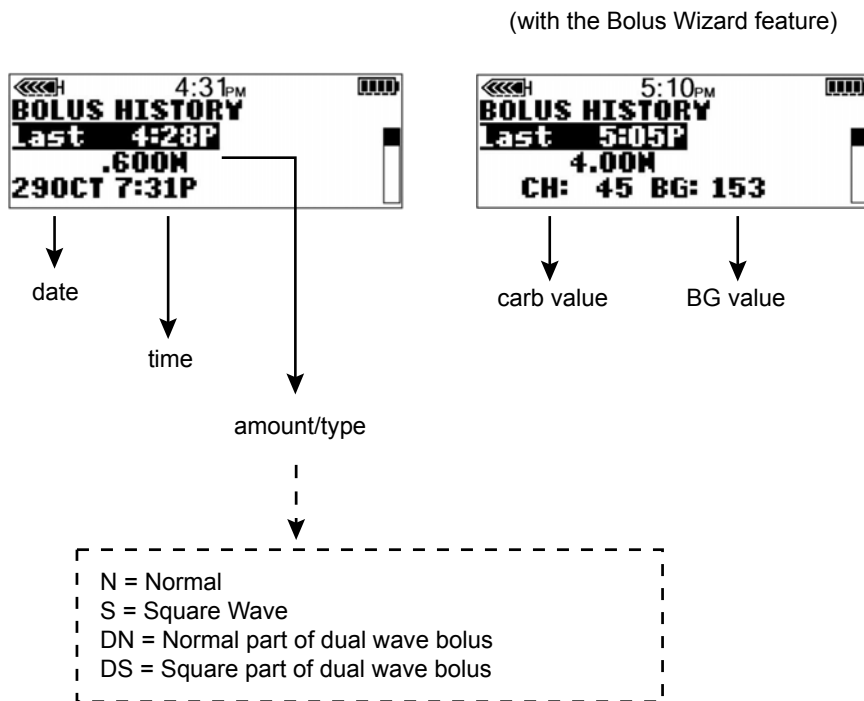

2. Refer to the instructions in the *Bolus details* section to see the details for any of these boluses.

## Bolus details

You can view the details of any of the deliveries in the BOLUS DETAIL screen. The details include:

- bolus types: normal, square, and dual
- programmed bolus amount
- delivered bolus amount
- Bolus Wizard feature information (if used)

### To see the details of any bolus, do these steps:

1. In the BOLUS HISTORY screen, select the bolus that you want to review and press **ACT**.
2. The details for that bolus will appear on the screen. Scroll through the details.

Without the Bolus Wizard feature

delivery is active

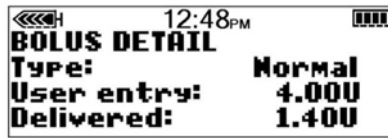

delivery stopped

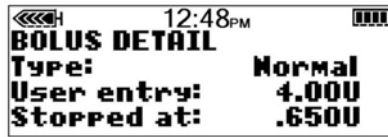

delivery completed

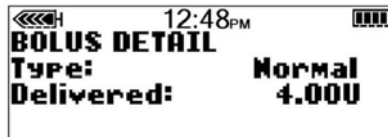

With the Bolus Wizard feature

If the Bolus Wizard feature calculated your bolus, more information will appear in the BOLUS DETAIL screen.

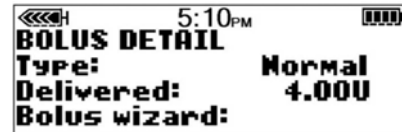

Press the down key to see the details

3. Exit when you are done.

## Maximum bolus limit

The Maximum bolus (Max bolus) is a safety feature that limits the amount of insulin that can be delivered in a single bolus. The factory setting is 10.0 units. You can specify the limit from 0.0 to 25.0 units. Set your Max bolus amount as prescribed by your healthcare professional.

**To set the Maximum bolus limit, do these steps:**

1. Go to the MAX BOLUS SETUP screen.  
**Main > Bolus > Bolus Setup > Max Bolus**
2. Set your Max bolus limit and press **ACT**. To accept the set Max bolus limit, press **ACT**. To change this limit, press **ESC**, and then set a lower Max bolus limit.
3. Your Max bolus is set. Exit the menus.

### Example 1: Max bolus

Shelby takes very small doses of insulin for her meal boluses. As a safety limit, her healthcare professional had her reset her pump with a Maximum bolus of 5.0 units.

### Example 2: Max bolus

David is a growing teenager. He loves to eat big meals and requires very large doses of insulin for his food. David's healthcare professional had him reset his pump with a Maximum bolus of 20.0 units so he can take more insulin when needed.

## Scroll rate

The scroll rate feature allows you to program bolus insulin delivery in preset increments. These increments are effective on all bolus screens, except for the SET EASY BOLUS screen. See the *Easy bolus setup* section in the *Optimizing pump therapy* chapter for more information on how to set up the steps for your Easy Bolus. The factory setting for the scroll rate feature is 0.10 units, and the available options are 0.025, 0.05, or 0.10 unit increments.

When you set the scroll rate to 0.025, you can use the following increments to program a bolus:

- 0.025 unit increments for a bolus of 0.975 units or less
- 0.05 unit increments for a bolus between 1 unit and 9.95 units
- 0.10 unit increments for a bolus of 10 units or more

When you set the scroll rate to 0.05, you can use the following increments to program a bolus:

- 0.05 unit increments for a bolus of 9.95 units or less
- 0.10 unit increments for a bolus of 10 units or more

When you set the scroll rate to 0.10, the increments will increase or decrease by 0.10 units during bolus programming regardless of the bolus value.

### To program your scroll rate:

1. Go to the SET SCROLL RATE screen.

**Main > Bolus > Bolus Setup > Scroll Rate**

2. The scroll rate value appears flashing. Change the value and press **ACT**.
3. The pump returns to the BOLUS SETUP screen. Your scroll rate is now programmed and ready to use. Exit the menus.

### Example: Scroll rate

You have set your scroll rate to 0.025 units. You need to set your pump to deliver a 2.5 unit bolus. The bolus values on the SET BOLUS screen will change in 0.025 unit increments until you reach 1.0 unit. After this the value will change in 0.05 unit increments until you reach 2.5 units in the SET BOLUS screen.

### BG Reminder

After you deliver a bolus you may want to check your blood glucose. The BG Reminder is an optional feature that makes the pump beep or vibrate to remind you to check your blood glucose after a bolus. However, this reminder is not available after an Easy Bolus. Your pump is set at the factory with the BG Reminder feature turned off.

When setting a bolus, if the BG Reminder is on, your pump will ask you to set up the BG Reminder Duration. This sets how long after bolus delivery you will be reminded to check your BG. This time can be from 30 minutes to 5 hours, or NONE. The BG Reminder is not available after an Easy Bolus.

#### To set up a BG reminder:

1. Go to the BG REMINDER SETUP screen.  
**Main > Bolus > Bolus Setup > BG Reminder**
2. Select **On** and press **ACT**. The BG Reminder is now enabled. Exit the menus.  
Now, the next time you program a bolus, your pump will ask you for the amount of time after your bolus before you want to be reminded to check your blood glucose.

When the BG Reminder goes off, your pump will beep or vibrate and CHECK BG will appear on the screen. Your pump will beep or vibrate periodically until it is cleared (**ESC, ACT**).



When you set a BG Reminder after a bolus, the STATUS screen will show the amount of time remaining before the reminder goes off. Here, the STATUS screen indicates that the BG Reminder will go off in 18 minutes.

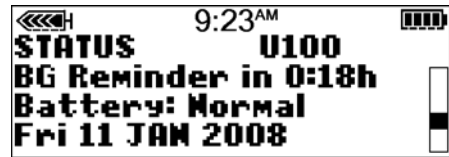

## Capturing Events

The Capture Event is an optional feature that allows you to manually save certain types of information. Some examples include:

- Blood glucose (BG) measurements
- The amount of insulin you use
- The amount of carbohydrates you eat or drink
- The exercise you do
- Other (this can be used for anything else as needed)

When using this feature, enter events when they happen since the system records the time of the entry. The entered information can be sent to Medtronic CareLink® Personal software. Here it can be used to generate reports that you can use when consulting with your healthcare professional. You can view up to 10 of the latest saved events in the CAPTURE HISTORY screen.

## Turning on the Capture Event feature

The Capture Events option appears in the MAIN MENU after this feature has been turned on in the UTILITIES MENU.

### To turn on the Capture Event feature, do these steps:

1. Go to the CAPTURE EVENT ON/OFF screen:  
**Main > Utilities > Capture Option**
2. Select **On**, then press **ACT**.

You will now have a Capture Event option in the MAIN MENU.

## Manually entering BG measurements

You can save non-calibrating BG readings in device history. Non-calibration meter BG measurements are those that are taken at times when you will not use them for calibration, such as after eating or when your blood glucose is rising or falling rapidly. You also have the option of using the entered BG reading for calibration purposes. Do **not** calibrate if your sensor is not communicating with your device.

### To enter the BG measurement:

1. Make a note of the BG measurement.
2. Go to the ENTER BG screen.

#### Main > Capture Event > Enter BG

The ENTER BG screen flashes with dashes or the most recent meter BG measurement you entered.

3. Enter your new measurement, then press **ACT**. The BG measurement must be between 20–600 mg/dL. A message asks if you want to save the new measurement that is shown on the screen.
  - If the information is correct, select **Save BG**, then press **ACT**. Your BG is saved.
  - If the Bolus Wizard feature is off, the CAPTURE EVENT screen appears.
  - If the Bolus Wizard is on and the saved BG is below your BG Target range, the BG Saved screen appears. This screen indicates that your saved BG is below your BG Target set in the Bolus Wizard feature, and the pump beeps three times. See *Setting the BG Targets*, on page 88 for more information.
  - If you want to use the new BG measurement for calibration, select **Save and Calibrate**. This option is available when the Auto Calibration feature is **Off** and your sensor is communicating with the pump. The BG measurements must be between 40 mg/dL and 400 mg/dL.
  - If the Bolus Wizard is on, the saved BG is above your BG Target range, and the calculated correction estimate is more than the preset scroll rate increment, the BG Saved screen appears. This screen indicates that your saved BG is above your BG Target set in the Bolus Wizard feature, and the

pump beeps three times. Go to the ENTER BG screen of the Bolus Wizard feature to enter a correction bolus. See *Setting the BG Targets*, on page 88 for more information.

- If the information is not correct, select **Cancel**, then press **ACT**. The CAPTURE EVENT screen reappears with **Enter BG** selected. Repeat the procedure and enter the correct information.

## Entering manual insulin injection information



**WARNING:** Insulin doses entered under Capture Events are not included in Bolus Wizard calculations of active insulin. Therefore, do not use the Bolus Wizard to calculate a bolus for a period of time after giving a manual injection by syringe or pen. Since the Bolus Wizard does not account for manual injections, it could prompt you to deliver more insulin than needed. Too much insulin may cause hypoglycemia. Consult with your healthcare professional for how long you need to wait after a manual injection before you can rely on the active insulin calculation of your Bolus Wizard.

If you have injected insulin using either an insulin pen or a syringe, follow these steps to manually enter the amount of insulin you have injected. (All insulin delivered by the pump is automatically recorded. You do not need to manually enter this information)

1. Go to the ENTER INSULIN screen.

**Main > Capture Event > Insulin Marker**

The ENTER INSULIN screen flashes with dashes or the insulin amount that you most recently entered.

2. Enter the amount of insulin you used, then press **ACT**. A message appears asking you if you want to save this information. The **Yes** option is selected.
3. Make sure that the amount of insulin shown on the screen is correct.
  - If the information is correct, press **ACT**. The information you entered is saved to the system and can now be used in reports.

- If the information is **not** correct, select **No**, then press **ACT**. The CAPTURE EVENT menu shows. Repeat the procedure to enter the correct information.

## Entering carbohydrate information

This section shows you how to enter information about the carbohydrates you eat or drink.

### Before you begin

Before you can enter carbohydrate information, you must select the carbohydrate units (Carb Units) for the Capture Event feature. You can set the carbohydrate units to grams or exchanges.

#### To set the carbohydrate units:

1. Go to the CARB UNITS screen.  
**Main > Capture Event > Carb Units**
2. Select either **Grams** or **Exchanges**, then press **ACT**. The CAPTURE EVENT menu shows. You are now ready to enter your carbohydrate information.

#### To enter carbohydrate information:

1. Determine the total units of carbohydrates in the meal or snack that you plan to eat.
2. Go to the ENTER FOOD screen.  
**Main > Capture Event > Meal Marker**
3. The ENTER FOOD screen flashes with dashes or with the number of carbohydrate grams or exchanges you entered last time.
4. Enter the carbohydrate grams or exchanges, then press **ACT**. A message asks if you want to save the information that is displayed on the screen. The **Yes** option is selected.
5. Make sure the number shown on the screen is correct.
  - If the information is correct, press **ACT**. The information you entered is saved to the system and can now be used in reports.

- If the information is **not** correct, select **No**, then press **ACT**. The CAPTURE EVENT menu shows. Repeat the steps above to enter the correct information.

## Entering exercise information

Follow these steps to enter exercise information. Be consistent and enter the marker either before or after each time you exercise.

1. Follow the path below to save your exercise information:  
**Main > Capture Event > Exercise Marker**
2. A message asks if you want to save this exercise.
3. Make your selection, then press **ACT**.

## Entering Other markers

This section shows you how to enter markers other than Enter BG, Insulin Marker, Meal Marker, or Exercise Marker. Examples of Other markers include: when you take medications, when you feel ill, when you are under stress, and so on. The Other marker appears in CareLink Personal reports, and shows at what time you have entered it in the Capture Event feature.

### To enter Other markers:

1. Follow the path below to save your Other marker:  
**Main > Capture Event > Other**  
A message asks if you want to enter this marker.
2. Select **Yes**, then press **ACT**. Your pump saves your Other marker and returns to the CAPTURE EVENT screen.

## Viewing Capture Event history

You can view up to 10 captured events saved into the device. The most recent event will be displayed at the top of the CAPTURE HISTORY screen.

### To view the Capture Event history:

1. Go to the CAPTURE HISTORY screen:  
**Main > Capture Event > History**

2. The CAPTURE HISTORY screen displays the saved events. Each event has the date and time when it was saved, the name, and any detail associated with that event.

## Basal

Basal insulin is required to maintain your target blood glucose values when you are not eating. Your healthcare professional will calculate this rate for you. Your basal insulin accounts for approximately one half of the body's total daily insulin requirements. Your pump mimics your pancreas by delivering insulin continuously over 24 hours.

You can set your insulin pump to change rates during the day to match your needs. Your needs depend on your lifestyle and insulin requirements. Some people only use one rate throughout the day, while others find they need more. Your basal rates are made up of insulin deliveries that have start and stop times. Once set, these rates make up your 24-hour basal pattern and are repeated daily.

### Start and stop times

When you set your basal rate(s) in the BASAL MENU, your pump prompts you to set the start time for each basal delivery. The start time of one basal rate is the stop time of the previous rate. This gives you continuous basal insulin through a 24-hour period. For basal rate 1, the start time is midnight (00:00 or 12:00 a.m.) and cannot be changed. See the following sample graph of basal rates.

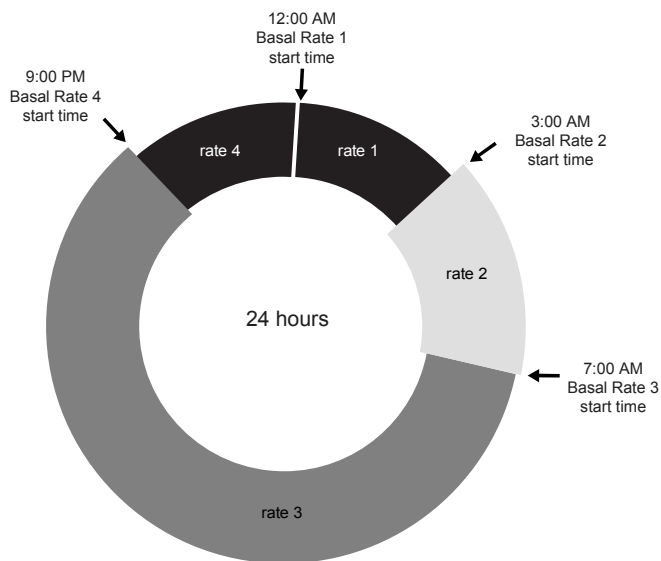

The start and stop times of basal rates for this example are:

- 12:00 a.m. (00:00) to 2:59 a.m. (2:59) for basal rate 1
- 3:00 a.m. (3:00) to 6:59 a.m. (6:59) for basal rate 2
- 7:00 a.m. (7:00) to 8:59 p.m. (20:59) for basal rate 3
- 9:00 p.m. (21:00) to 11:59 p.m. (23:59) for basal rate 4

If you need one basal insulin that starts before midnight and stops after midnight, you need to set up two basal rates. These basal rates have the same rate but different start and stop times. For example, in this graph a basal rate is needed from 9:00 p.m. to 2:59 a.m. (21:00 to 2:59) at one rate. Basal rate 1 always starts at midnight and should be set to end at 2:59 a.m. (2:59). After setting basal rates 2 and 3, rate 4 is set from 9:00 p.m. (21:00) to 11:59 p.m. (23:59) at the same rate as basal rate 1. This gives continuous basal insulin from 9:00 p.m. to 2:59 a.m. (21:00 to 2:59) at one rate.

You cannot set a start time for one basal rate to overlap the next basal rate. The addition of a new basal rate will erase any basal rates that follow.

Consult your healthcare professional when setting or changing your basal rate(s).

## Your basal settings

You must program your basal settings before you can deliver basal insulin. Keep a written record of your prescribed basal settings.

You should set your prescribed basal rates with the assistance of your healthcare professional.

If you plan to take off your pump for an extended period of time, such as more than a day, set the basal rate to 0.000 U/H. This will ensure that the insulin delivery records in your pump are accurate. Refer to the *If you remove your pump* section in *The basics* chapter for more information.

## Basal programming and delivery



**Note:** You cannot make changes to your basal rate settings while a percent temp basal is active.

### To set your basal rates:

1. Go to the SET BASAL RATE 1 screen.  
**Main > Basal > Basal Setup > Set/Edit Basal**
2. The SET BASAL RATE 1 screen flashes the basal rate in U/H.
3. Enter your first basal rate amount and press **ACT**.  
The start time for your first basal rate is midnight and cannot be changed.
4. The SET START TIME 2 screen appears. The dashes under the screen name flash. The first basal rate is now set.  
If you do not need a second basal rate for the day, press **ESC**. If you need to set up a second basal rate for the day, follow steps 5 and 6.
5. In the SET START TIME 2 screen, enter the start time for the next rate.
6. Press **ACT**. The SET BASAL RATE 2 screen appears. Enter the rate.
7. Press **ACT**. The SET START TIME 3 screen appears. The second basal rate is now set. If you do not need to set up any more basal rates for the day, press **ESC** and skip to step 9. If you need to set up more basal rates, follow steps 5 and 6 for each basal rate.
8. After you program your last basal rate, press **ESC**.



- The BASAL RATE screen appears. Your basal rate(s) will now deliver as programmed. Exit the menus.



**Note:** The pump delivers basal amounts in 0.025 U/H increments for basal rates of less than 1.00 U/H, and in 0.05 U/H increments for basal rates of 1.00 U/H or more.

- When you have finished programming your pump, you can save your settings. Refer to the *User settings* section in the *Utilities* chapter for instructions.

### Current basal delivery

The STATUS screen shows your current basal information.

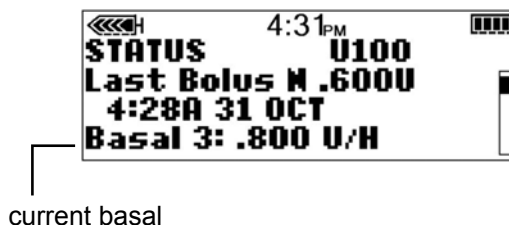

### Daily basal rate(s)

The BASAL REVIEW screen shows your daily basal rates programmed for delivery from midnight to midnight. Compare your daily insulin deliveries to your blood glucose records, and consult your healthcare professional to identify your optimal daily basal insulin rate(s).

#### To review your basal rates, do these steps:

- Go to the BASAL MENU screen.
  - Main > Basal
- Select **Basal Review** and press **ACT**.
- If you do not use patterns, the STANDARD screen appears.

The delivery details for your standard basal will appear.

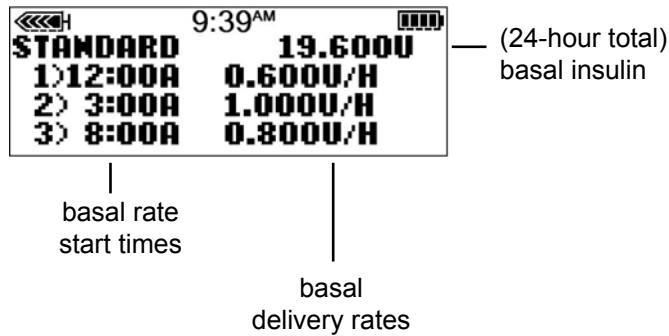

If you use patterns, the BASAL REVIEW screen appears.

The current basal pattern will be highlighted. Select the pattern you want to view. Press **ACT**.

The delivery details for that pattern will appear.

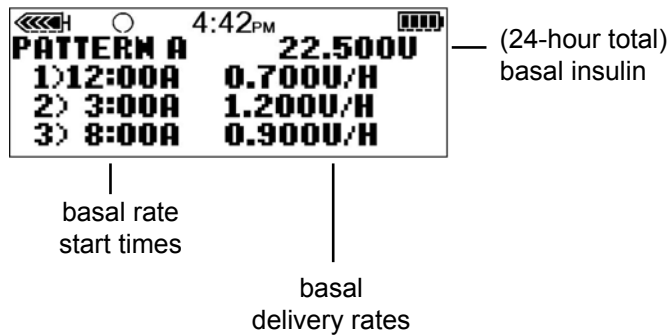

- Exit the menus when you are done.

## Setting the Max basal rate

Maximum basal (Max basal) rate is a safety limit for the amount of basal insulin that is able to be delivered per hour. Your pump is sent from the factory with the Max basal set to 2.00 units per hour. Consult your healthcare professional to determine your Max basal rate. This safety feature will not allow you to program any basal rates, including patterns and temporary basal rates, that are greater than the Max basal rate.

If you are setting your Max basal rate after your basal rates have been set, you **cannot** set a Max basal that is less than any of the programmed basal rates.

### To set your Max basal rate, do these steps:

1. Go to the MAX BASAL RATE screen. The Max basal rate will be flashing.  
Main > Basal > Basal Setup > Max Basal Rate
2. Change the rate and press **ACT**.
3. Your Max basal rate is now set. Exit the menus.

### Example 1: Max basal

Helen has a very low insulin requirement. Her highest basal rate is only 0.400 units per hour. As a safety measure, Helen's healthcare professional set her pump with a Maximum basal rate of 1.00 units per hour.

### Example 2: Max basal

Rusty needs large amounts of insulin to control his blood glucose levels. His new pump was delivered from the factory with a Maximum basal rate of 2.00 units per hour, but he needs 2.80 units per hour in the early morning. Rusty will reprogram his Maximum basal to 3.00 units per hour to accommodate his needs.

## Stopping your pump

Manual **Suspend** stops all insulin delivery, including the current basal and any bolus or Fill Cannula deliveries that are in progress. While manually suspended, your pump will not deliver insulin until you manually resume your pump. When you resume your pump, the basal delivery will continue.

The pump will beep or vibrate about every 15 minutes on the hour to remind you that it is not delivering insulin. Example: You manually suspend your pump at 11:20 AM. The pump will beep/vibrate at 11:30 AM, 11:45 AM, 12:00 PM, and so on until you resume your pump (basal resumes).

When manually suspended, your pump is in Attention mode with a solid circle showing on the pump. When in manual **Suspend**, you can only resume your basal or view the STATUS screen. Any bolus or Fill Cannula deliveries that were in progress when you suspended, will not resume.

If the Sensor feature is turned on, you can also view the sensor graphs and the SENSOR STATUS screen. No other functions are available.

## To manually suspend the pump:

1. Select **Suspend** from the MAIN MENU, and press **ACT**.

Main > Suspend

2. SUSPEND will flash on your screen. Press **ACT** to stop your pump.
3. The screen will show that the pump is manually suspended and the time that it stopped. After less than one minute, the pump will return to the HOME screen with a solid circle.

You can verify on your pump STATUS screen that your pump is manually suspended.

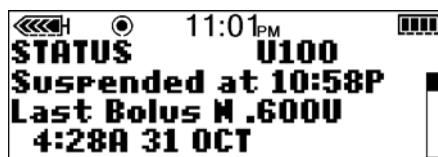
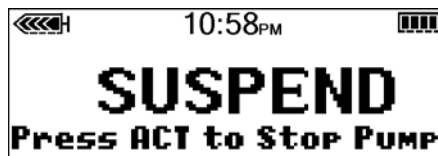

## Resume pump delivery

When the pump is manually suspended, it defaults to the HOME screen with a solid circle.

### To resume your pump and basal delivery, do these steps:

1. From any screen, press **ACT** until the RESUME screen appears. Press **ACT** again.
2. Your pump will beep once, then the HOME screen will appear without the solid circle.



**Caution:** A bolus delivery or fill cannula that was suspended does not restart when you resume. To avoid a high BG and ketoacidosis, always check the pump's Bolus History or Reservoir + Set History after you resume insulin delivery to determine the amount that was delivered. If needed, program a new bolus or fill cannula delivery.

**Example:**  
**Manual Suspend function**

Helen is ready to eat her lunch. She has just programmed her pump to deliver a meal bolus when the phone rings. Helen wants to talk on the phone and not eat her lunch right away. She knows that if she lets the bolus continue and she does not eat her lunch soon, she may be at risk for low blood glucose. Helen manually suspends delivery of her pump to stop the bolus, but then resumes delivery to restart her basal insulin. When she is off the phone and ready to eat, she checks her STATUS screen to see how much insulin she received from the partially delivered bolus before she manually suspended her pump. She will reprogram a new bolus for the remainder of her bolus amount.

**Practice:**  
**Manual Suspend function**

1. **Make sure you are NOT connected to your pump while practicing.**  
 Program your pump to deliver a Normal bolus of 3.0 units. Once the bolus begins, stop the bolus by manually suspending your pump.  
**Remember, when you stop the bolus delivery with SUSPEND, all insulin delivery will stop.**
2. Now, RESUME delivery, so that your basal insulin will continue.
3. Check the STATUS screen.
4. How much insulin did the bolus deliver before you manually suspended delivery? \_\_\_\_\_.
5. If you wanted to take the rest of the bolus later, how much would you take to equal 3.0 units? \_\_\_\_\_.

**Practice:**  
**Resume basal delivery after a manual Suspend**

**Make sure you are NOT connected to your pump while practicing.**

1. Give a 3.0 unit bolus now. While it is delivering, manually suspend the bolus.
2. Check here if you were able to manually suspend the bolus.
3. Now restart the pump.

4. Check here if you were able to restart the pump.

4



starting on insulin





# 4

## Starting on insulin

The pump is intended for use with U100 insulin. The following insulins have been tested by Medtronic Diabetes and found to be safe for use in MiniMed 530G insulin pumps:

- Humalog
- Novolog

Before using different insulin with this pump, check the insulin label to make sure the insulin can be used with the pump.



**WARNING:** Never start on insulin until directed by your healthcare professional. Do not use insulin in your pump while you are practicing by either inserting an insulin filled reservoir into your pump, or connecting an insulin filled infusion set to your body. Doing so could result in an infusion of insulin, not prescribed by your healthcare professional, which may cause low or high BG.

### Prepare your pump for use

Watch your pump training CD-ROM and complete your pump start training before continuing with the steps in this chapter.



**WARNING:** Check your time, date, and prescribed settings. If these are not correct when you use your pump, then your insulin will not deliver as prescribed by your healthcare professional.

You will need these items:

- Pump
- Insulin (U100)
- Reservoir and user guide
- Infusion set and user guide

## Setting up the reservoir



**WARNING:** Always allow your insulin to reach room temperature before use. Cold insulin can cause air bubbles in the reservoir and tubing which may result in inaccurate insulin delivery.

## Filling the reservoir



**WARNING:** Do not use the reservoir or infusion set if any liquid gets on the top of the reservoir or inside the tubing connector (as shown in the image). Liquid can temporarily block the vents. This may result in the delivery of too little or too much insulin, which can cause hypoglycemia or hyperglycemia. If any liquid gets on the top of the reservoir or inside the tubing connector, start over with a new reservoir and infusion set.

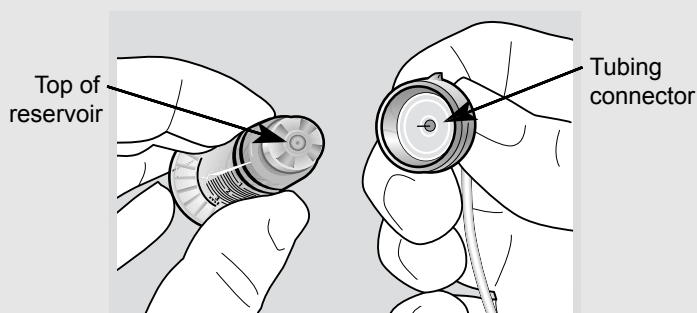

## To fill the reservoir, do these steps:

1. Remove the reservoir from the package, and fully extend the plunger.

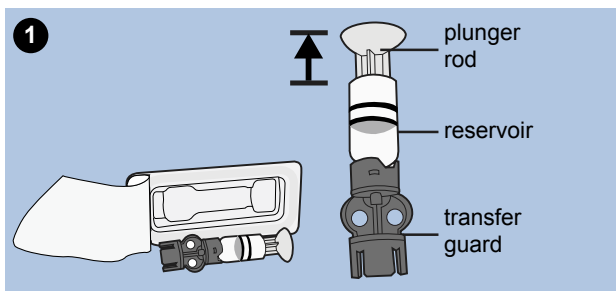

2. Swab the vial with alcohol (not shown).
3. Press the transfer guard onto the vial without pushing down on the plunger.

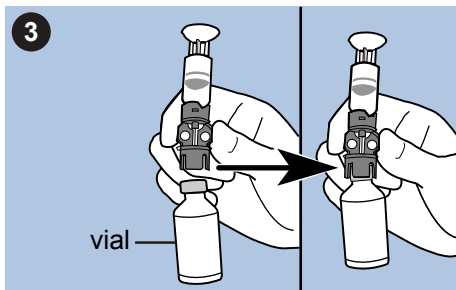

4. Push down on the plunger to pressurize the vial. Hold down the plunger rod.
5. While still holding down the plunger rod, flip the vial over so the vial is upright. Slowly pull down on the plunger to fill the reservoir.
6. Gently tap the side of the reservoir to make any air bubbles rise to the top of the reservoir.

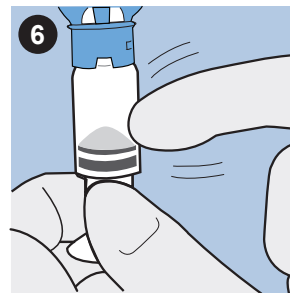
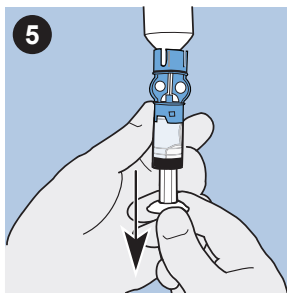
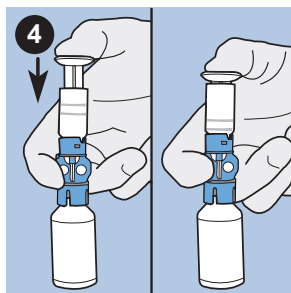

7. Slowly push up on the plunger just enough to remove any air bubbles from the reservoir.
8. Slowly pull down on the plunger to fill the reservoir to the number of units desired.
9. To avoid getting liquid on the top of the reservoir, flip the vial over so that it is upright. Turn the reservoir counter-clockwise, then pull straight up to remove the reservoir from the transfer guard.
10. Place the tubing connector onto the reservoir. Turn the connector clockwise, pressing gently against the reservoir until you feel it slide in. Push in and continue turning until the reservoir and the connector lock with a click.

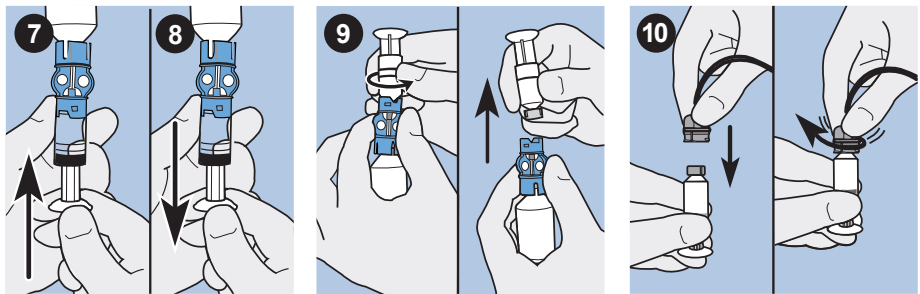

11. Tap the side of the reservoir to remove any air bubbles.
12. To purge air bubbles that have risen to the top of the reservoir, push up on the plunger until you see insulin in the tubing.
13. Without pulling, turn the plunger counter-clockwise to remove it from the reservoir.

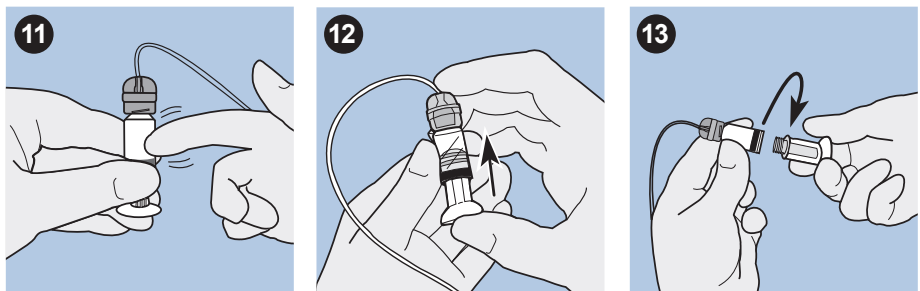

14. Insert the reservoir into the reservoir compartment immediately after filling it.

## Changing your infusion set

You must do all the tasks in the following list every time you change your infusion set. Follow the procedures in this section in the order they are presented.

- Remove the old reservoir from your pump.
- Rewind your pump.
- Insert the new filled reservoir into your pump.
- Fill the tubing.
- Insert the infusion set into your body.
- Fill the cannula.



**Note:** You need your filled reservoir to complete the following procedures. If necessary, return to the previous section for instructions on filling your reservoir.

## Removing the reservoir

**To remove the reservoir, do these steps:**

1. Remove the entire infusion set from your body.
2. If attached, remove the activity guard.
3. Turn the tubing connector half-turn counter clockwise, then pull the reservoir and connector out from the pump.

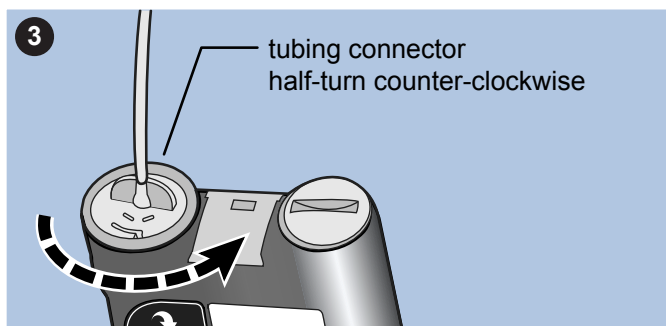

4. Safely dispose of the used reservoir and infusion set item in a sharps container.

5. You must now rewind your pump as described in the next section.

## Rewinding your pump

Before you continue, make sure the infusion set is NOT connected to your body and the reservoir is NOT in the pump.



**WARNING:** Make sure the infusion set is disconnected from your body before you rewind your pump or fill the infusion set tubing. Never insert the reservoir into the pump while the tubing is connected to your body. Doing so could result in an accidental infusion of insulin, which may cause low BG.



**WARNING:** If you are practicing, do not rewind or insert the reservoir into your pump. Doing so could result in an accidental infusion of insulin, which may cause low BG. Make sure the red shipping cap is installed in the reservoir compartment as shipped. Consult your healthcare professional before starting on insulin.

### To rewind your pump, do these steps:

1. If you removed your reservoir and are replacing it, go to the REWIND screen.  
Main > Reservoir + Set > Reservoir Setup
2. In the REWIND screen, press **ACT** to start the rewind process. The REWINDING screen will appear while the pump rewinds.
3. After the pump rewinds the REWIND COMPLETE screen will appear.
4. Continue to the next section to insert the reservoir in your pump.

## Inserting the reservoir in your pump

If you are practicing, do not insert the reservoir in your pump.



**Caution:** You must rewind your pump before installing a new reservoir to ensure correct insulin amount.



**Note:** A pump rewind is required to start the infusion set change process.

### To insert the reservoir in your pump, do these steps:

1. If you are using the pump for the first time, remove the red shipping cap from the reservoir compartment.



**WARNING:** Never insert the reservoir into the pump while the tubing is connected to your body. Doing so could result in an accidental infusion of insulin, which may cause low BG.

2. Rewind your pump if you have not done so. See *Rewinding your pump*, on page 70 for instructions.
3. Insert the reservoir into the top of the pump case.
4. Turn the tubing connector approximately 1/2 -turn clockwise until the connector is seated. The tubing connector should be aligned horizontally with the pump case as shown here.

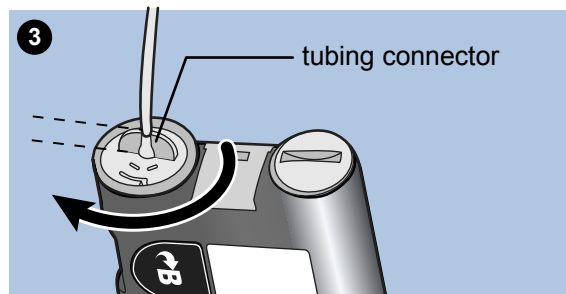
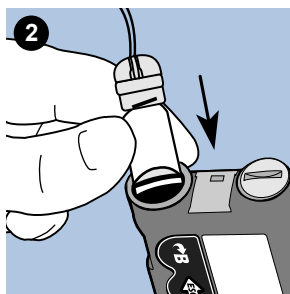

5. Attach the activity guard, if desired.
6. If the pump has returned to the HOME screen, press **ACT** to show the REWIND COMPLETE screen. Press **ACT** again to go to the FILL TUBING screen.
7. You must now fill the infusion set tubing as described in the next section.

### Filling the tubing

You need to fill the infusion set tubing with insulin before you insert the set into the body.



**WARNING:** Make sure the infusion set is disconnected from your body before you rewind your pump or fill the infusion set tubing. Never insert the reservoir into the pump while the tubing is connected to your body. Doing so could result in an accidental infusion of insulin, which may cause low BG.

**To fill the tubing, do these steps:**

1. After you rewind your pump, the FILL TUBING screen will appear.
  - a. If the infusion set is **NOT** disconnected from your body, press **ACT** to select **No** on the screen. After you disconnect the infusion set from your body, press **ACT** on the next screen to continue.
  - b. If the infusion set is disconnected from your body, select **Yes** on the FILL TUBING screen. Press **ACT** to continue to the next FILL TUBING screen.
2. Press and hold **ACT**. The pump will beep six times indicating that the pump is positioning the reservoir.
3. After the reservoir is positioned, you need to fill the infusion set tube with insulin. Press and hold **ACT** until insulin droplets form on the tip of the infusion set needle, then release. Follow the instructions on the screen. You will hear beeps as the pump fills the tubing with insulin. Be sure no bubbles are in the tubing.



**WARNING:** Always check your tubing for air bubbles. Continue to hold **ACT** until the bubbles have been removed from the tubing. Air bubbles may result in inaccurate insulin delivery.

If you use more than 30 units of insulin to fill the infusion set tubing, the MAX FILL REACHED alarm screen will appear. If you get this alarm, do these steps:

- a. Make sure that you are not connected to the pump.
- b. Read the message on the screen, then press **ESC**, **ACT** to clear.



- c. To continue filling the infusion set tubing, select **Yes, Continue** and press **ACT**. See the next step to continue. If you have made a mistake, select **No, Rewind** and press **ACT**. The REWIND screen will appear. Refer to the pump rewinding and insulin loading instructions in this chapter to continue.
4. A message will appear: DO YOU SEE DROPS AT END OF TUBING?  
Select **Yes** or **No**.
  - a. If you do NOT see drops at the tip of the needle, select **No** and press **ACT**. Make sure your infusion set is NOT connected to your body. Follow the instructions on the FILL TUBING screens to continue filling the infusion set tubing with insulin.
  - b. If you see drops formed at the tip of the needle, select **Yes** and press **ACT**. The FILL CANNULA screen will appear.
5. You can now insert the infusion set into your body as described in the next section.

### Inserting the infusion set



**WARNING:** Do not remove the reservoir from the pump while the infusion set is connected to your body. This could lead to over or under delivery of insulin.

After you complete all of the following, you will be ready to insert the infusion set into your body:

- fill your reservoir
- rewind your pump
- insert the reservoir into pump
- and fill the infusion set with insulin

Shown here are the best body areas (shaded) for infusion set insertion. Avoid the 2-inch (5.0 cm) area around the navel to help ensure a comfortable infusion site, and to help with adhesion.

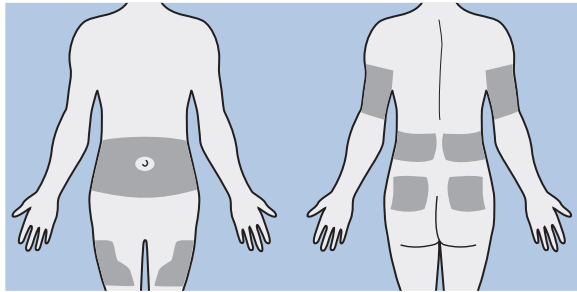

**Caution:** Change your infusion set every two to three days to avoid infusion set occlusion or site infection.



**Caution:** Rotate the infusion set insertion sites so that they do not become overused.

To keep sites healthy, some people find it helpful to use a visual scheme to help them rotate their insertion sites in an organized way. For example, here are two commonly used methods. For maximum effectiveness, use both methods, alternating between them:

- Visualize an imaginary clock drawn on your abdomen surrounding your belly button. Rotate infusion set insertion sites by starting at 12 o'clock and then rotate the site clockwise to 3 o'clock, 6 o'clock, and so on.
- Imagine a letter M or a letter W on either side of your belly button. Start at the end of one letter and proceed through the letter, rotating to each intersection in turn.

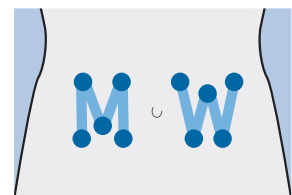
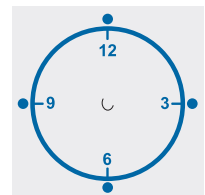

Medtronic Diabetes offers different infusion sets for your pump. Instructions for the Quick-set® begin on the next page as an example. Always refer to the instructions that shipped with your infusion set.

After your infusion set is inserted, see the *Filling the cannula* section in this chapter to fill the infusion set cannula.

### Quick-set infusion set (with Quick-serter®)

There are different infusion sets that you can use with your pump. As an example, the following procedure shows how to insert the Quick-set infusion set. Always refer to the instructions that shipped with your infusion set.

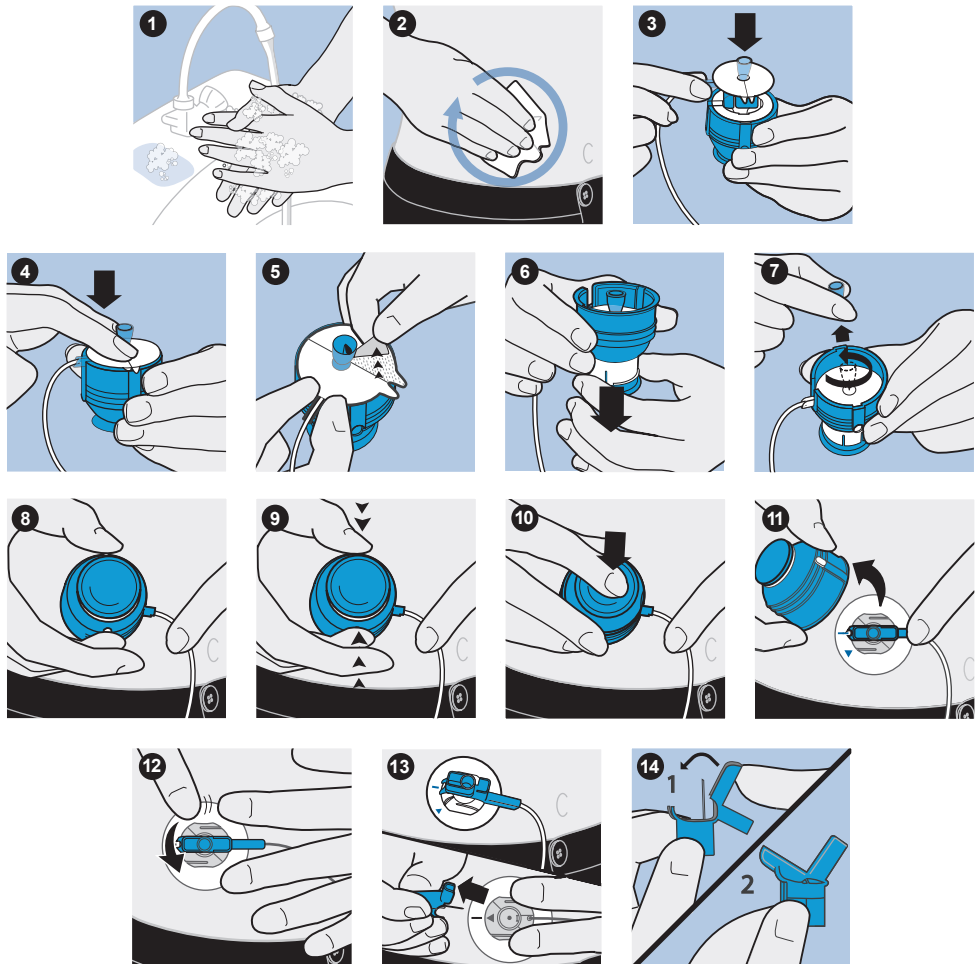

## Filling the cannula

Filling the soft cannula with insulin is required after the infusion set is inserted into your body and the introducer needle is pulled out. The insulin amounts required to fill the cannula depend on the type of infusion set you are using. Refer to your infusion set instructions for this information. If you are using an infusion set with a needle, press **ESC** to skip this step.

If you do not complete the Fill Cannula steps, your pump triggers a FINISH LOADING alarm. If you need to skip the Fill Cannula step, press **ESC** to avoid getting this alarm.

1. After you have filled the infusion set tubing, the FILL CANNULA screen appears. It displays a message to connect the infusion set to your body. Press **ACT** to fill the cannula. To skip this step, press **ESC** until you see the MAIN MENU screen. If you do not complete this step, the RESERVOIR + SET MENU screen appears after 15 minutes. After 10 minutes, your pump triggers a FINISH LOADING alarm.
2. Enter the amount for your type of infusion set, then press **ACT**. If your infusion set has a needle cannula, press **ESC** to get to the MAIN MENU screen in order to skip this step. If you do not complete this step, the RESERVOIR + SET MENU screen appears after one minute. After 10 minutes, your pump triggers a FINISH LOADING alarm.
3. As the cannula starts filling, the FILLING CANNULA screen will count up the units as they are delivered. The pump will beep or vibrate when the cannula is full.

### To see how much insulin was delivered to fill the infusion set:

1. Go to the HISTORY screen.  
**Main > Reservoir + Set > History**
2. Scroll through the list of insulin deliveries. The letter T at the end of the text line indicates that insulin was delivered to fill the tubing. The letter C at the end of the text line indicates insulin was delivered to fill the cannula. Exit the menus.

## Disconnecting the Quick-set infusion set

The Quick-set infusion set allows you the freedom to temporarily disconnect from your pump without removing the infusion set from your body.

1. Hold the side grips of the connector part with your fingers.
2. Twist the connector counter-clockwise.
3. Remove the connector from the site.

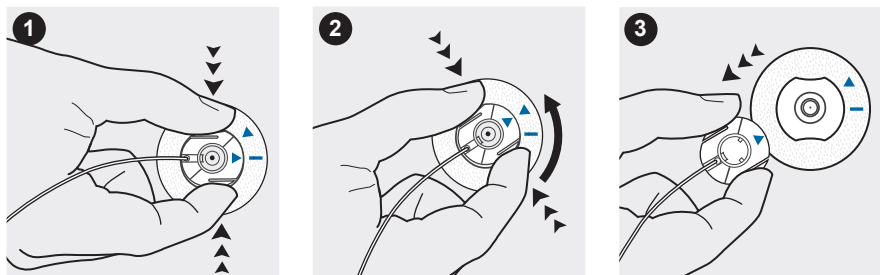

## Reconnecting the Quick-set infusion set

Place the connector part (flat side facing down) on the infusion site until it is fully seated. Do not squeeze the connector part by the flat side grip. Doing so may prevent a proper connection.

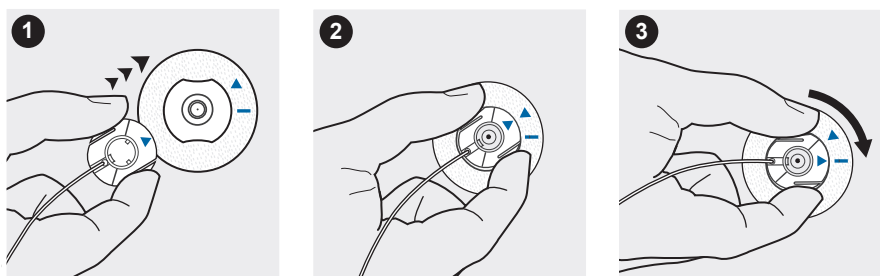

## Determining your pump settings

Your healthcare professional will use your daily blood glucose journal records to program your pump. It is very important to keep good records during the first weeks after you start on pump therapy. Not only must you record your blood glucose readings, but it will be important to eat regularly scheduled meals and to keep your activity as consistent as possible.

While you are working with your healthcare professional to determine the pump settings that will work best for you, it is important to eat meals for which it is easy to count the carbohydrates. After your correct basal rate is determined, consult your healthcare professional if you want to experiment with varied food choices and amounts.

■ using the bolus wizard feature

5





# 5 Using the Bolus Wizard feature

## What is it?

Bolus Wizard is a feature that calculates an estimated bolus to support your food intake or to correct a high blood glucose. To use this feature, you need the following information:

### Carbohydrate counting

You need to know which foods contain carbohydrates and how to count these.

### Your blood glucose reading

You need to know your blood glucose (BG) reading. When using the Bolus Wizard feature, the pump can work with Bayer's CONTOUR® NEXT LINK Wireless

Meter, which is powered by MWT1 technology to automatically receive your blood glucose reading. MWT1 is the wireless Radio Frequency (RF) technology that is used to transmit information from the meter to the pump. To program your pump to automatically receive your BG reading from this meter, see *Meter option, on page 187*. If you are not using a supported meter, you must manually enter your blood glucose.



### Your personal Bolus Wizard feature settings

In addition to your blood glucose reading or your food entry, the Bolus Wizard feature uses personal settings that you program into the pump. (For instructions see the *How to program the Bolus Wizard feature* section in this chapter.)

- carb units (grams or exchanges)
- carb ratios (in carbohydrate grams/unit of insulin or insulin units/carb exchanges)
- insulin sensitivity
- target blood glucose range
- active insulin time (hours)

Get your prescribed settings from your healthcare professional, and always consult your healthcare professional before changing your settings. Keep a record of your settings in the following *Bolus Wizard feature settings* table:

Bolus Wizard feature settings		
Information	Setting	
<b>Carb units:</b>	_____ grams or _____ exchanges	
<b>Carb ratios:</b>	<b>Ratio:</b>	<b>Start time:</b>
Bolus Wizard feature uses this for your food bolus calculations.	1. _____	1. midnight
If you count carbs, this ratio is the amount of carbohydrate grams covered by one unit of insulin.	2. _____	2. _____
<b>range: 1–200 grams/unit</b>	3. _____	3. _____
If you count exchanges, this ratio is the amount of insulin you need to cover one (carb) exchange.	4. _____	4. _____
<b>range: 0.075–15.0 units/exchange</b>	5. _____	5. _____
	6. _____	6. _____
	7. _____	7. _____
	8. _____	8. _____

 **Note:** Your carb ratios may vary throughout the day. Your pump allows you to program up to eight different carb ratios.

## Bolus Wizard feature settings

### Information

### Setting

#### Insulin sensitivity:

This ratio is used for your correction bolus calculations.

This ratio is the BG units reduced by 1.0 unit of insulin.

range: 10–400 mg/dL/u



**Note:** Your insulin sensitivity may vary throughout the day. Your pump allows you to program up to eight different insulin sensitivities.

#### Ratio:

1. \_\_\_\_\_
2. \_\_\_\_\_
3. \_\_\_\_\_
4. \_\_\_\_\_
5. \_\_\_\_\_
6. \_\_\_\_\_
7. \_\_\_\_\_
8. \_\_\_\_\_

#### Start time:

1. midnight
2. \_\_\_\_\_
3. \_\_\_\_\_
4. \_\_\_\_\_
5. \_\_\_\_\_
6. \_\_\_\_\_
7. \_\_\_\_\_
8. \_\_\_\_\_

#### BG Target range:

If your current blood glucose is above the BG Target range, the Bolus Wizard feature will calculate a correction dose. If your current blood glucose is below the BG Target range, the Bolus Wizard feature will calculate a negative correction and subtract it from your food bolus.

range: 60–250 mg/dL



**Note:** Your pump will allow you to program up to eight different BG Target ranges.

#### Range:

1. \_\_\_\_\_
2. \_\_\_\_\_
3. \_\_\_\_\_
4. \_\_\_\_\_
5. \_\_\_\_\_
6. \_\_\_\_\_
7. \_\_\_\_\_
8. \_\_\_\_\_

#### Start time:

1. midnight
2. \_\_\_\_\_
3. \_\_\_\_\_
4. \_\_\_\_\_
5. \_\_\_\_\_
6. \_\_\_\_\_
7. \_\_\_\_\_
8. \_\_\_\_\_

#### Active insulin time:

The Bolus Wizard feature uses this time to calculate the active insulin in your system (see the *About active insulin* section in this chapter).

range: 2–8 hours

Number of Hours: \_\_\_\_\_

## How the Bolus Wizard feature works

1. If you want your current blood glucose to be factored in, enter your BG Reading:
  - automatically from the meter (refer to the *Meter option* section)
  - manually by selecting the **↻B** button
2. If you are going to eat, enter your food amount in grams or exchanges.
3. The Bolus Wizard feature will calculate a bolus for you. An ESTIMATE DETAILS screen will appear with your estimated total bolus amount.

## Bolus Wizard warnings

When using the Bolus Wizard feature, the pump may display a HIGH BG, LOW BG, and MAX BOLUS EXCEEDED warnings.

### HIGH BG

If your blood glucose in the ENTER BG screen is above 250 mg/dL, the Bolus Wizard feature displays a HIGH BG warning. Read the instructions, then press **ACT** or **ESC** to clear the message. You can then continue programming to deliver your bolus.

### LOW BG

If your blood glucose in the ENTER BG screen is below 70 mg/dL, the Bolus Wizard feature displays a LOW BG warning. Read the instructions, then press **ACT** or **ESC** to clear the message. You can then continue programming to deliver your bolus.

### MAX BOLUS EXCEEDED

Bolus Wizard feature will not deliver more than the limit set for your maximum bolus. If the Bolus Wizard feature calculates a bolus amount that is larger than your max bolus limit setting, the message, MAX BOLUS EXCEEDED will appear. If this happens, do these steps:

1. In the MAX BOLUS EXCEEDED screen, press **ACT** to continue your bolus programming. The EST : MAX screen appears with the estimated and maximum bolus amounts. Continue to the next step.

If you do not want to continue, press **ESC** to cancel and the screen will return to the ENTER BG screen.

2. In the EST : MAX screen, press **ACT** again to continue your bolus programming.
3. The SET BOLUS screen appears with the maximum bolus amount flashing. Enter the bolus amount. This amount cannot be more than the max bolus amount. Press **ACT**.
4. The BOLUS DELIVERY screen appears showing the insulin units being delivered.
5. The pump will beep/vibrate after it has completed the insulin delivery.

## How to program the Bolus Wizard feature

You need your personal settings from the Bolus Wizard feature settings table to setup the Bolus Wizard feature. Your Bolus Wizard feature settings are programmed in the EDIT SETTINGS screen.

**Main > Bolus > Bolus Setup > Bolus Wizard Setup > Edit Settings**

Once the settings are programmed, you do not have to program them again unless the values change. After you program one setting, the screen will automatically go to the next required setting. After you program all your settings, review them as described in this section to make sure they are set correctly.

Instructions for programming the Bolus Wizard feature settings are in the next paragraphs. Program your settings in the order described to make sure you program all the settings. If you have not completed setting up all of the required settings, MISSING INFO screen appears. It lists the required settings for this feature. You must program the listed settings before you can use the Bolus Wizard feature.

## Turning on the Bolus Wizard feature

1. Go to the EDIT SETTINGS screen.

**Main > Bolus > Bolus Setup > Bolus Wizard Setup > Edit Settings**

2. The EDIT SETTINGS screen appears with **Wizard: Off** selected. Press **ACT**.
3. The WIZARD ON/OFF screen appears. Select **On**, then press **ACT**.

4. The EDIT SETTINGS screen appears, showing that the wizard is now turned on. You are now ready to select your carb units.

## Selecting the Carb units

The carb unit setting lets the pump know which way to count your carbohydrates (grams or exchanges).

1. Make sure the EDIT SETTINGS screen is open.  
**Main > Bolus > Bolus Setup > Bolus Wizard Setup > Edit Settings**
2. Select **Carb Units**, then press **ACT**.
3. The CARB UNITS screen appears. Select **Grams** or **Exchanges**, then press **ACT**.
4. The EDIT SETTINGS screen shows the carb units you selected. You are now ready to set your carb/exchange ratios.

## Setting the Carb/Exch ratios

Your pump allows you to set up to eight Carb/Exch ratios because this ratio may vary throughout the day. Your healthcare professional may only have you program one or two carb ratios when you first start using the Bolus Wizard feature.

### To set the Carb/Exch ratios:

1. Make sure the EDIT SETTINGS screen is open.  
**Main > Bolus > Bolus Setup > Bolus Wizard Setup > Edit Settings**
2. Select **Carb Ratios**, then press **ACT**.
  - **If you use grams as your carb units:** Carb ratio is the number of carb grams that are covered by one (1.0) unit of insulin.
  - **If you use exchanges as your carb units:** Carb ratio is the number of insulin units that are needed to cover one (1.0) carb exchange.
3. The SET CARB RATIO 1 (if you are using grams) or SET EXCH RATIO 1 (if using exchanges) screen appears. The default ratio flashes on the screen.
4. Set your first ratio, then press **ACT**. Carb ratio values are normally between 5–50 grams/u or 0.3–3.0 u/exch. If your ratio value is outside the range, a warning message will appear on the screen. This message warns that the entered carb ratio is valid but outside the usual range. Press **ESC** to correct or **ACT** to continue.

The start time for your first ratio is midnight and cannot be changed.

5. The SET START TIME 2 screen appears. The dashes under the screen name flash. The first Carb Ratio or Exchange Ratio is now set.  
If you do not need a second ratio, press **ESC** and skip to the next section. If you need to set up another ratio, follow steps 6 through 9.
6. In the SET START TIME 2 screen, enter the time of the day you want this ratio to become active.
7. Press **ACT**. The SET CARB RATIO 2 screen (if using grams) or SET EXCH RATIO 2 screen (if using exchanges) appears.
8. The default ratio flashes. Select your ratio.
9. Press **ACT**. The SET START TIME 3 screen appears. The second carb or exchange ratio is now set.
10. If you do not need to set up any more ratios, press **ESC**. If you need to set up more ratios, repeat steps 6 through 9 above for each ratio.

You are now ready to set your insulin sensitivity.

### Insulin sensitivity

Your insulin sensitivity is the amount your blood glucose (BG) level is reduced by one unit of insulin. This value is used to calculate a suggested insulin dose to correct a high BG. Because this sensitivity may vary throughout the day, your pump lets you set up to eight sensitivity settings. Your healthcare professional may only have you program one or two insulin sensitivities when you first start using the Bolus Wizard feature. Record your settings in the *Bolus Wizard feature settings* table in this chapter.

1. Make sure the EDIT SETTINGS screen is open.  
**Main > Bolus > Bolus Setup > Bolus Wizard Setup > Edit Settings**
2. Select **Sensitivity**, then press **ACT**.
3. The INS SENSITIVITY 1 screen appears. The default sensitivity value of 50 mg/dL/u flashes on the screen.
4. Set the value for your first insulin sensitivity setting, then press **ACT**. Insulin sensitivity values are normally between 20–100 mg/dL/u. If your value is outside this range, a warning message will appear on the screen.

The start time for your first insulin sensitivity is midnight and cannot be changed.

5. The SET START TIME 2 screen appears. The dashes under the screen name flash. The first insulin sensitivity is now set.

If you do not need a second insulin sensitivity, press **ESC** and skip to the next section. If you need to set up another insulin sensitivity, follow steps 6 through 9.

6. In the SET START TIME 2 screen enter the time of the day you want this insulin sensitivity to become active.
7. Press **ACT**. The INS SENSITIVITY 2 screen appears.
8. The default sensitivity value flashes. Set the value for this insulin sensitivity.
9. Press **ACT**. The SET START TIME 3 screen appears. The second insulin sensitivity is now set.
10. If you do not need to set up any more insulin sensitivities, press **ESC**. If you need to set up more insulin sensitivities, repeat steps 6 through 9 above for each insulin sensitivity.

You are now ready to set up the BG Target.

## Setting the BG Targets

The BG Target setting allows you to set glucose targets. The Bolus Wizard will use your BG targets to calculate a correction dose. Because the targets may vary throughout the day, your pump allows you to set up to eight BG Targets each day. If you want to set just one target value, instead of a range, set both the low and high values to the same number.

If your current BG is above the BG Target range, the Bolus Wizard feature may calculate a correction dose. The correction dose will deliver enough insulin to bring your BG down to your current high end of the BG Target range. If your current BG is below the BG Target range, the Bolus Wizard may calculate a negative correction and subtract it from your food bolus. This will bring your BG to the low end of the BG Target range.

### Example:

Pumps are sent from the factory with default BG Target range of 100–100 mg/dL.



1. Make sure the EDIT SETTINGS screen is open.  
**Main > Bolus > Bolus Setup > Bolus Wizard Setup > Edit Settings**
2. Select **BG Target**, then press **ACT**.
3. The TARGET RANGE 1 screen appears. The low end of your BG Target range flashes on the screen.
4. Set the BG Target, then press **ACT**.
5. The high end of your BG Target range flashes on the screen. Enter the BG Target, then press **ACT**.

The start time for your first BG Target is midnight and cannot be changed.

6.
  - a. If your BG Target is outside of 90–140 mg/dL, the pump screen displays a warning that the values are acceptable but outside normal range. Press **ESC** to change your BG Target or press **ACT** to set this range.
  - b. If your BG Target is within 90–140 mg/dL, the SET START TIME 2 screen appears. The dashes under the screen name flash. The first BG Target range is now set.

If you do not need a second BG Target range, press **ESC** and skip to the next section. If you need to set up another BG Target range, follow steps 7 through 11.

7. In the SET START TIME 2 screen enter the time of the day you want this BG Target range to become active.
8. Press **ACT**. The TARGET RANGE 2 screen appears.
9. The low end of your BG Target range flashes on the screen. Set the BG Target, then press **ACT**.
10. The high end of your BG Target range flashes on the screen. Enter the BG Target, then press **ACT**.
11. The SET START TIME 3 screen appears. The second BG Target range is now set.
12. If you do not need to set up any more BG Target ranges, press **ESC**. If you need to set up more BG Target ranges, repeat steps 7 through 11 above for each one.

You are now ready to set up the Active insulin time.

## About active insulin

Active insulin is the bolus insulin that has already been delivered to your body, but has not yet been used. The pump considers your active insulin time setting in determining any active insulin still in your body from prior boluses. This may help prevent hypoglycemia caused by over-correcting for high blood glucose.

The pump shows the active insulin amount in the ESTIMATE DETAILS screen during the Bolus Wizard programming steps, the STATUS and the SET BOLUS screens. However, the active insulin amount is calculated differently in the ESTIMATE DETAILS screen and appears with an asterisk (\*Active Insulin). The active insulin amount calculated in the Bolus wizard steps includes the insulin that has already been delivered and insulin that is going to be delivered by the active Square Bolus.

Your pump is shipped from the factory with an active insulin time setting of six hours, which most closely matches the published scientific data. If your healthcare professional prescribes a different time for you, the active insulin time setting can be adjusted in the Bolus Wizard menu in one-hour increments from two to eight hours.

For more details about active insulin, see the *Bolus Wizard feature specifications* section in the *Pump specifications* chapter.



**WARNING: Do not use the Bolus Wizard to calculate a bolus for a period of time after giving a manual injection by syringe or pen. The Bolus Wizard does not account for manual injections, and could prompt you to deliver more insulin than needed. Too much insulin may cause hypoglycemia. Consult with your healthcare professional for how long you need to wait after a manual injection before you can rely on the active insulin calculation of your Bolus Wizard.**

## Active insulin time

The active insulin time setting lets the pump know which active insulin time to use in calculating the amount of active insulin to subtract before estimating a bolus. Your healthcare professional will prescribe the active insulin time that is best for you.

**To set the Active insulin time, do the following steps:**

1. Make sure the EDIT SETTINGS screen is open.  
**Main > Bolus > Bolus Setup > Bolus Wizard Setup > Edit Settings**
2. Select **Active Ins Time**, then press **ACT**.
3. The ACTIVE INS TIME screen appears. The default time of 6 hours flashes on the screen.
4. Set the number of hours for the active insulin time, then press **ACT**.
5. The EDIT SETTINGS screen shows the new Active insulin time setting. You have now completed the Bolus Wizard setup. Press **ESC** or wait to see the message: **Bolus Wizard setup is complete**.

**Review your Bolus Wizard feature settings**

Check your Bolus Wizard feature settings in the REVIEW SETTINGS screen. If necessary, compare this information with your information in the Bolus Wizard feature settings table.

1. Go to the REVIEW SETTINGS screen.  
**Main > Bolus > Bolus Setup > Bolus Wizard Setup > Review Settings**
2. Scroll through the text to view your Bolus Wizard settings.
3. Exit the menus when you are done.

**Normal bolus using Bolus Wizard feature**

After the Bolus Wizard feature is turned on and programmed, this feature can calculate an estimate of insulin you need for your correction bolus or your food bolus. You have the option of using the estimate or changing it as necessary. Additionally, your pump can receive your blood glucose reading from the meter, if they are linked.

Use the **↻B** button to deliver a Normal bolus at any time except during another Normal bolus. A Normal bolus will temporarily interrupt a Square Wave or Dual Wave bolus that is delivering. After the Normal bolus is finished, the Square Wave or Dual Wave bolus delivery will resume.



**Note:** If you want to use the pump-to-meter link, make sure the meter option is on. Refer to the *Meter option* section for instructions.

1. If you want a correction bolus, check your blood glucose with your blood glucose meter and go to step 2. If you want to bolus for food, go to step 2.
2. Press **⌂B** on your pump, or go to the BOLUS MENU, select **Use Bolus Wizard**, and press **ACT**.
3. The ENTER BG screen will appear.
  - a. If you are **not** using the meter:

Enter your blood glucose value. Press **ACT** and continue to step 4. If you are not entering a blood glucose and want to bolus for food, select the dashes in the ENTER BG screen. The Bolus Wizard feature will calculate the insulin needed for your food entry without considering your blood glucose level. Press **ACT** and continue to step 4.
  - b. If you are using the meter, you must program your bolus within 12 minutes of the pump receiving the reading from the meter. If more than 12 minutes have passed, the reading will no longer be available from the screen and you must enter your blood glucose manually.

Your pump checks if the entered BG is within your target range. Press **ACT** to accept the blood glucose value. You can also change this blood glucose value, if necessary, then press **ACT**.
4. The ENTER FOOD screen appears.
  - a. If this is a food bolus, enter the food value you will eat, then press **ACT**.
  - b. If this is a correction bolus, select 0 (zero) as the value, then press **ACT**.
5. The ESTIMATE DETAILS screen appears. Review the information on this screen. If you need to make any changes, press **ESC** to return to the ENTER BG screen (step 3) and make changes as necessary.
6. Press **ACT** in the ESTIMATE DETAILS screen. The SET BOLUS screen appears with the estimated bolus amount flashing. Change the amount if desired. Press **ACT** to accept and start delivering your bolus.



**Note:** If you have BG Reminder turned On, the BG REMINDER DURATION screen displays. It allows you to set the duration before you are reminded to check your blood glucose after a bolus. See the *BG Reminder* section in the *Basic programming* chapter for information about this feature.

7. The BOLUS DELIVERY screen appears. The pump will beep or vibrate at the start and end of the bolus. As the bolus is delivered, the screen shows the bolus type and amount until the total units have been delivered. The screen then returns to the HOME screen.

## Bolus Wizard feature examples

For the scenarios that follow, Michael has his Bolus Wizard feature turned on with the following settings:

Carb ratio: 15 grams per unit of insulin

Insulin Sensitivity: 40 mg/dL per unit of insulin

BG Target: 90–120 mg/dL

Active Insulin Time: 6 hours



**Note:** If you want to see details of the formulas the Bolus Wizard feature uses to calculate estimate boluses like the ones in the following examples, see the *Bolus Wizard feature specifications* section in the Pump specifications chapter.

### Example 1: Blood glucose on target (normal blood glucose) and no active insulin

Michael awakens in the morning before school and his mother has breakfast waiting for him. Before he begins eating, he tests his blood glucose with his meter and his blood glucose result of 120 mg/dL is automatically sent to his pump.

He estimates that his meal consists of 60 grams of carbohydrates. When prompted by the Bolus Wizard feature, he enters this amount in the ENTER FOOD screen. Based on his Bolus Wizard feature settings, the pump will suggest that he take 4.0 units of insulin.

**Food estimate:**

Carb grams ÷ Carb ratio = Units of insulin

$$60 \text{ g} \div 15 \text{ g/u} = 4 \text{ units}$$

**Correction estimate:**

Correction is 0 because the current BG reading is within the BG Target range.

**Total bolus estimate:**

Food estimate + Correction estimate = Units of insulin

$$4 \text{ units} + 0 \text{ units} = 4 \text{ units}$$

**Example 2: Blood glucose above target (high blood glucose) and no active insulin**

The next day, Michael wakes up before school. Before eating the same breakfast, he tests his blood glucose with his meter and finds it to be 200 mg/dL, which is above his target of 120 mg/dL. His blood glucose reading is automatically sent to his pump.

When prompted by the Bolus Wizard feature, he enters his carbohydrate amount of 60 grams in the ENTER FOOD screen. Based on his settings, the pump will suggest that he take 6.0 units of insulin.

**Food estimate:**

Carb grams ÷ Carb ratio = Units of insulin

$$60 \text{ g} \div 15 \text{ g/u} = 4 \text{ units}$$

**Correction estimate:**

(Current BG - High BG Target) ÷ Insulin sensitivity = Units of insulin

$$(200 \text{ mg/dL} - 120 \text{ mg/dL}) \div 40 \text{ mg/dL/u} = 2 \text{ units}$$

**Total bolus estimate:**

Food estimate + Correction estimate = Units of insulin

$$4 \text{ units} + 2 \text{ units} = 6 \text{ units}$$

### Example 3: Blood glucose below target (low blood glucose) and no active insulin

When prompted by the Bolus Wizard feature, he enters his carbohydrate amount of 60 grams in the ENTER FOOD screen. Based on his settings, the pump will suggest that he only take 3.5 unit of insulin.

**Food estimate:**

Carb grams ÷ Carb ratio = Units of insulin

$$60 \text{ g} \div 15 \text{ g/u} = 4 \text{ units}$$

**Correction estimate:**

(Current BG - Low BG Target) ÷ Insulin sensitivity = Units of insulin

$$(70 \text{ mg/dL} - 90 \text{ mg/dL}) \div 40 \text{ mg/dL/u} = -0.5 \text{ units}$$

**Total bolus estimate:**

Food estimate + Correction estimate = Units of insulin

$$4 \text{ units} + (-0.5) \text{ units} = 3.5 \text{ units}$$

### Example 4: Blood glucose above target (high blood glucose) with active insulin

**Food estimate:**

Carb grams ÷ Carb ratio = Units of insulin

$$60 \text{ g} \div 15 \text{ g/u} = 4 \text{ units}$$

**Correction estimate:**

(Current BG - High BG Target) ÷ Insulin sensitivity - Active insulin = Units of insulin

$$(200 \text{ mg/dL} - 120 \text{ mg/dL}) \div 40 \text{ mg/dL/u} - 1.5 \text{ units} = 0.5 \text{ units}$$

**Total bolus estimate:**

Food estimate + Correction estimate = Units of insulin

$$4 \text{ units} + 0.5 \text{ units} = 4.5 \text{ units}$$

## Example 5: Blood glucose below target (low blood glucose) with active insulin

When prompted by the Bolus Wizard feature, he enters his carbohydrate amount of 60 grams in the ENTER FOOD screen. Based on his settings, and despite 1.5 units of active insulin, his pump will suggest that he take 3.5 units of insulin.

### Food estimate:

Carb grams ÷ Carb ratio = Units of insulin

$$60 \text{ g} \div 15 \text{ g/u} = 4 \text{ units}$$

### Correction estimate:

(Current BG - Low BG Target) ÷ Insulin sensitivity - Active insulin = Units of insulin

$$(70 \text{ mg/dL} - 90 \text{ mg/dL}) \div 40 \text{ mg/dL/u} - 0^* = -0.5 \text{ units}$$



**Note:** \*When the current BG is below the Low BG Target, an active insulin amount is not considered in the Bolus Wizard feature calculations.

### Total bolus estimate:

Food estimate + Correction estimate = Units of insulin

$$4 \text{ units} + (-0.5) \text{ units} = 3.5 \text{ units}$$



# 6



# 6

## Optimizing pump therapy



**WARNING:** This chapter contains advanced features. Do not use the features in this chapter until you are completely familiar with the basic pump functions. If you use these features incorrectly, your insulin may not deliver as prescribed by your healthcare professional. Consult your healthcare professional before using advanced features on your pump.

### Square Wave and Dual Wave bolus

**Square Wave bolus** delivers a bolus evenly over a period of time (30 minutes to 8 hours). This bolus can be used for insulin delivery when you have eaten a long meal or extended snacking. It can also be useful if you have delayed food digestion due to gastroparesis or meals high in fat. A Square Wave bolus can be useful if a Normal bolus drops your blood glucose too rapidly. Since the Square Wave portion extends over a period of time, the insulin is more likely to be available to match your individual needs.



**Note:** During delivery of a Square Wave bolus, you will not be able to do the following pump functions: change the max bolus amount, change the scroll rate, disable or deliver Dual and Square Wave boluses, rewind or

fill the cannula, change the active insulin time, run a Selftest, or access the User Settings menu. All other pump functions are still available during the Square Wave bolus.

**Dual Wave bolus** delivers a combination of an immediate Normal bolus followed by a Square Wave bolus. The Square Wave portion is delivered evenly over a period of time. A Dual Wave bolus is useful for meals with both rapidly and slowly absorbed carbohydrates. For example, a Dual Wave bolus would be appropriate for fruit and crackers followed by pasta. The Dual Wave option meets both immediate and extended insulin needs. A Dual Wave bolus is also useful for correcting elevated blood glucose before a meal.

See the following graphic for a description of the different bolus types:

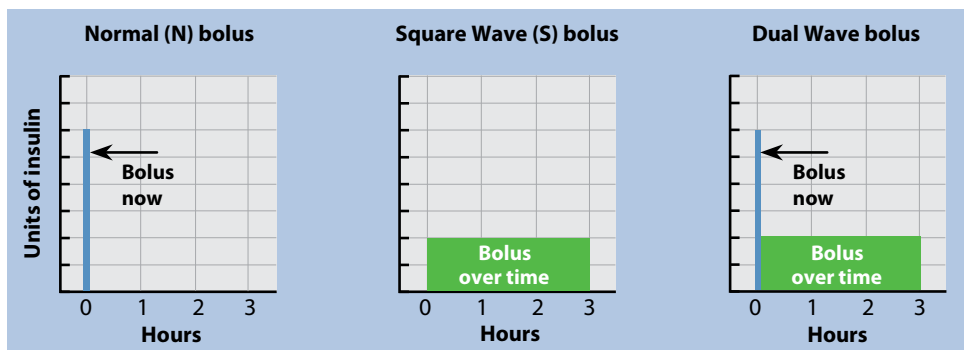

## Turning on the Dual Wave/Square Wave option

Consult with your healthcare professional before using a Square Wave or Dual Wave bolus. You should be familiar with the basic functions of your pump before you use these options.

**To set up a Dual Wave or Square Wave bolus, you must first turn on the dual/square bolus option.**

1. Go to the DUAL/SQUARE OPTION screen.  
Main > Bolus > Bolus Setup > Dual/Square Bolus
2. Select **On**, then press **ACT**. The feature is now on. Exit the menus.

## Square Wave or Dual Wave bolus without Bolus Wizard feature

1. Make sure the dual/square option is on.



2. Calculate your food or correction bolus amount.
3. Go to the BOLUS TYPE screen.

Press **B** on your pump, or follow this path:

**Main > Bolus > Set Bolus**

4. **For a Square Wave bolus, do these steps:**
  - a. Select **Square Wave Bolus**, then press **ACT**. The SET SQUARE BOLUS screen appears.
  - b. Enter the desired amount for the Square Wave bolus units, then press **ACT**.
  - c. Continue to step 5.

**For a Dual Wave bolus, do these steps:**

- a. Select **Dual Wave Bolus**, then press **ACT**. The SET DUAL BOLUS TOTAL screen appears.
  - b. Enter the desired amount for the total dual bolus units. This amount is the total of Normal and Square Wave bolus units. Press **ACT**.
  - c. The next screen flashes the amounts of Now (Normal) and Square Wave portions of the Dual Wave bolus. The screen also shows the percentage amount of each portion. Press  or  to change the percentage/number of units. Continue to step 5.
5. The SQUARE DURATION screen appears. Enter the amount of time you want the Square Wave bolus to last, then press **ACT**.



**Note:** If you have BG Reminder turned On, the BG REMINDER DURATION screen displays. It allows you to set the duration before you are reminded to check your blood glucose after a bolus. See the *BG Reminder* section in the *Basic programming* chapter for information about this feature.

6. The BOLUS DELIVERY screen appears with an open circle indicating that your pump is in Special mode. The pump beeps/vibrates at the start of the bolus. During bolus delivery, the pump will return to the HOME screen. The pump beeps/vibrates at the end of the bolus and the open circle disappears.

## Square Wave bolus practice

Your target pre-meal blood glucose range is \_\_\_\_\_ to \_\_\_\_\_.

Check your pre-meal blood glucose. Are you within your target? \_\_\_\_\_. If yes, continue. If no, wait to try the following test until your pre-meal blood glucose is within your target range:

TEST: Choose a meal that is high in fat (hot dogs, pizza, cheese enchiladas).

Determine your meal bolus amount. Set the Square Wave bolus to deliver the determined amount of insulin over two hours. (This duration time is an example.

Always consult with your healthcare professional for guidance.)

Check your blood glucose and record:	Pre-meal _____
	1 hour post meal _____
	2 hours post meal _____
	3 hours post meal _____
	4 hours post meal _____

Did your blood glucose return to your pre-meal target within 4 hours post meal?

\_\_\_\_\_

If yes, then repeat this test with the same meal on another day to verify your results.

If no, consult your healthcare professional for guidance.

## Dual Wave bolus practice

Can you think of any meals where this feature would help you with blood glucose control?

Your target pre-meal blood glucose range is \_\_\_\_\_ to \_\_\_\_\_

Check your pre-meal blood glucose. Are you within your target? \_\_\_\_\_. If yes, continue. If no, try this test when your pre-meal blood glucose is within your target range:

TEST: Choose a meal that has a combination of both rapidly absorbed and slowly absorbed carbohydrates. Determine your meal bolus amount. Set the Dual Wave bolus to deliver the determined amount of insulin. Program your pump to deliver one-half over 2-hours\*, and the other half immediately.

(\* This duration of time and ratio is an example. Always consult with your healthcare professional for guidance.)

Check blood glucose and record:

Pre-meal\_\_\_\_\_

1 hour post meal\_\_\_\_\_

2 hours post meal\_\_\_\_\_

3 hours post meal\_\_\_\_\_

4 hours post meal\_\_\_\_\_

Did your blood glucose return to your pre-meal target within 4 hours post meal?  
\_\_\_\_\_\*

If yes, repeat this test with the same meal on another day to verify results.

If no, consult your healthcare professional for guidance.

### Using the Bolus Wizard feature for a Square Wave or Dual Wave bolus

If you are using the Bolus Wizard feature to calculate your Square Wave or Dual Wave bolus amounts, you will be prompted to enter your blood glucose reading or the (gram or exchange) units you will eat. The Bolus Wizard feature will use this input to calculate your suggested correction or food bolus amount. If you do not want to use the Bolus Wizard feature estimate, you can change it.

The Bolus Wizard feature must be turned on and the settings must be programmed (see the *How to program the Bolus Wizard feature* section in the *Using the Bolus Wizard* chapter). Also, make sure the dual/square option is turned on (see the *Turning on the Dual Wave/Square Wave option* section in this chapter).

If you want to use the pump-to-meter link, make sure the meter option is on. Refer to the *Meter option* section for instructions.

1. Go to the ENTER BG screen.

Press **B** on your pump, or use the following path:



**Main > Bolus > Use Bolus Wizard**

2. Enter your blood glucose value, then press **ACT**.
3. The ENTER FOOD screen appears. Enter your food, then press **ACT**.
4. The ESTIMATE DETAILS screen appears. Scroll down to review the information there. Press **ACT** to continue to step 5.

If you need to make any changes, press **ESC** to return to the ENTER BG screen. Make changes as necessary.

5. The BOLUS EST screen appears with Normal Bolus, Square Wave Bolus, and Dual Wave Bolus options. If your Bolus Wizard feature calculates that your bolus includes a portion to correct your high blood glucose, the Square Wave Bolus option will not be available. This helps you to select a bolus type (Normal or Dual Wave) that has an immediate delivery option to cover your high blood glucose.
6. **To set a Square Wave bolus, do these steps:**
  - a. In the BOLUS EST screen, select **Square Wave Bolus**, then press **ACT**.
  - b. The SET SQUARE BOLUS screen flashes the estimated bolus amount. Change the amount if needed. Press **ACT** to accept the bolus amount.

**To set a Dual Wave bolus, do these steps:**

- a. The SET DUAL BOLUS TOTAL screen flashes the estimated bolus amount. This amount is the total of both the Normal and Square Wave bolus units. Change the amount if needed. Press **ACT** to accept the bolus amount.
- b. The next screen flashes the amounts of Now (Normal) and Square portions of the Dual Wave bolus. The screen also shows the percentage amount of each portion. Press **ACT** to accept the Bolus Wizard's suggested portions. You can also press  or  to change these portions, then press **ACT**.

The Bolus Wizard feature recommends splitting the food portion of your bolus 50/50 between the Square and Now portions. The entire correction amount is always recommended to the Now portion. In this example the NOW portion consists of half of the food insulin plus the correction amount less the active insulin ( $1.5U + 2.5U - 1.5U$ ). This gives 2.5U or 62% of total insulin of 4.0U. The Square portion consists of the other half of the food insulin (1.5U), which is 38% of total insulin of 4.0U.

7. The SQUARE DURATION screen appears. Enter the amount of time you want the Square Wave bolus to last, then press **ACT**.







**Note:** If you have BG Reminder turned On, the BG REMINDER DURATION screen displays. It allows you to set the duration before you are reminded to check your blood glucose after a bolus. See the *BG Reminder* section in the *Basic programming* chapter for information about this feature.

8. Press **ACT** to accept and deliver the bolus. The BOLUS DELIVERY screen appears with an open circle indicating that your pump is in Special Mode. The pump beeps or vibrates at the start of the bolus. During bolus delivery, the pump returns to the HOME screen. If you want to see the progress of the delivery, press **ESC** to see the STATUS screen. The pump beeps or vibrates at the end of the bolus, and the open circle disappears.

## Easy bolus

The **EASY BOLUS** button  allows a quick way to deliver a Normal bolus. You will preset the settings for this feature in the EASY BOLUS OPTION screen in the BOLUS MENU. Your pump is sent from the factory with the Easy Bolus feature set to off. If you want to use Easy Bolus, turn it on.

After you set up Easy Bolus, with each  press, you can increase the Normal bolus amount by a fixed amount, called a step. Before you can deliver an Easy Bolus, you must set the amount in the EASY BOLUS ENTRY screen. This amount equals the number of units of insulin for each step. The maximum number of steps can equal up to your maximum bolus limit. When using vibrate mode, EASY BOLUS is limited to 20 steps or maximum bolus, whichever comes first.

After you set your step amount, you can program your Easy Bolus. When you are in the HOME screen, each time you press  the Easy Bolus amount increases by one step. You will hear a beep or feel a vibration for each step increase. Each beep is a different tone. This makes it easy for you to count the beeps while you are programming your Easy Bolus.

## Easy bolus setup

1. Go to the EASY BOLUS OPTION screen.

**Main > Bolus > Bolus Setup > Easy Bolus**

2. Select **On/Set**, then press **ACT**.



**Note:** If you are using the remote control, the Easy Bolus must be set to on.

Refer to the remote control user guide for instructions on operating your remote control.

## Step value setup

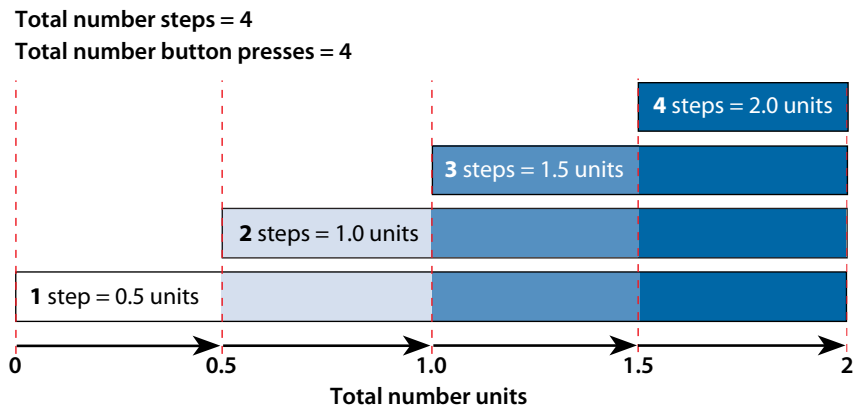

You can set the step value from 0.1 to 2.0 units, or to the set maximum bolus limit of less than 2.0 units (factory setting: 0.1). Set the step to a number that is convenient to use and easy to multiply.



1. The EASY BOLUS ENTRY screen flashes the step value. Change the value, then press **ACT**. The step value is the increment you will use for your Easy bolus.
2. The screen will return to the BOLUS MENU. Your step amount is now programmed and Easy Bolus is ready to use. Exit the menus.



## Delivering Easy Bolus

Practice using the Easy Bolus feature while looking at the pump screen as you count the beeps. This feature only works from the HOME screen. After you are familiar with Easy Bolus, you can use the audible tones for bolus delivery without having to look at the screen.



1. From the HOME screen, press . The SET EASY BOLUS screen appears with the single step value flashing.
2. Press  the number of times needed for your bolus amount. Watch the amount change on the screen with each press. The pump will vibrate or sound a different tone for each  press.



**Caution:** Always check your pump if you hear any unanticipated beeps or vibrations.

3. When your total bolus amount appears on the SET EASY BOLUS screen, press **ACT**. Listen/feel to count the steps without looking at the screen.  
For example: You need to deliver a 2.0 unit bolus, and your step size is set to 0.5. Each time you press , the units increase by the step amount of 0.5 units. To deliver 2.0 units, you need to press the  button four times. ( $4 \times 0.5 = 2.0$ ) The screen will show 2.0 units.





**Note:** You cannot use the  to select the Easy Bolus values. Pressing  or **ESC** will cancel the Easy bolus.

4. If this amount is correct, press **ACT** to start the Easy Bolus delivery. The BOLUS DELIVERY screen will show the units being delivered. When the total bolus is finished, the pump will beep or vibrate.  
If this amount is wrong, press **ESC** or  to start over. The pump will return to the HOME screen.

### Example 1: Easy bolus

Alexander is a busy executive with an accounting firm. He wears his pump on his belt and does not want to take it off to give himself a bolus. Alexander can easily reach down and feel for the Easy Bolus button  to give a bolus.

He previously programmed his pump to deliver an Easy Bolus in steps of 0.5 unit increments. From the HOME screen, with each press of the , the pump will sound a different tone so he can keep track of the number of button presses.

He wants to give himself 2.0 units for a snack, so he will press  4 times (4 presses x 0.5 units/press = 2.0 units) and then press the **ACT** button. The pump counts back 4 beeps because he pressed  4 times. He simply presses **ACT** to confirm the amount, and his pump delivers the 2.0 units.

When Alexander wants to be more discreet, or does not want his pump to beep in an important meeting, he can set the pump to Vibrate mode and feel for vibrations rather than listening for the tones. (See the *Setting your alert type* section in the *Utilities* chapter for details.)

### Your turn: Easy bolus practice

The factory default setting for the Easy Bolus feature is 0.1 unit steps. You can change the step level as necessary to a value that is more convenient for you to use and easier to multiply.

Give your next bolus by using the Easy Bolus feature on your pump.

Your step level is \_\_\_\_\_.

How many units did you give? \_\_\_\_\_

How many tones did you count? \_\_\_\_\_

It might be a good idea to look at your pump's screen to see the bolus amount as well as counting the steps the first few times you try this until you become familiar and comfortable with the feature.

### Missed Bolus Reminder

Missed Bolus Reminder feature helps you remember to give yourself a meal bolus. It triggers a MISSED BOLUS alert if you do not deliver a bolus during the time periods that you set. Set these time periods for the meals for which you want to receive a reminder. The pump is set at the factory with the Missed Bolus Reminder feature turned Off.

## Add, delete, and review bolus reminders

You have to turn on the Missed Bolus Reminder option to add, delete and review the programmed reminders.

1. Go to the MISSED BOLUS REMINDER screen.  
**Main > Bolus > Bolus Setup > Missed Bolus Reminder**
2. Select **On/Set**, then press **ACT**.

### Add

You can set up to four Missed Bolus Reminders.

1. Select **Add Reminder** on the MISSED BOLUS REMINDER screen, then press **ACT**.
2. The Start Time flashes. Times can be entered in 30 minute increments. Set the Start Time, then press **ACT**.
3. After this time is set, the End Time flashes. Set the End Time, then press **ACT**.  
If you enter the same Start Time and End Time, you will get one Missed Bolus Reminder in a 24 hour period. If you add a Missed Bolus Reminder with a start time earlier than the current pump time, you will not get this Missed Bolus Reminder until the next day.

### Delete

1. Select **Delete Reminder** on the MISSED BOLUS REMINDER screen and press **ACT**.
2. In the DELETE REMINDER screen, highlight the bolus reminder that you want to delete and press **ACT**.

### Review

1. Select **Review Reminders** on the MISSED BOLUS REMINDER screen and press **ACT**.
2. Review your Missed Bolus reminders.

## Basal patterns

The Basal Patterns feature is optional for pump users. You can set your pump to deliver a standard basal and two additional basal patterns to meet your individual daily, weekly, or monthly needs. Keep a paper copy of your programmed patterns with you at all times in case you need to reprogram your pump. To select and use pattern A or pattern B, the patterns option must be turned on and programmed.

- Standard pattern: Your normal basal that supports your usual day-to-day activity. When the Patterns feature is off, the pump uses your standard basal pattern.
- Pattern A/B: Basal pattern that supports activity levels that are not a part of your day-to-day routine, but are normal in your lifestyle. Such activities could be a sport that you do once a week or a change in your sleep pattern over the weekend, extended periods of higher or lower activity, or menses.

### Turning on the patterns

Your pump is set at the factory with the basal patterns feature turned off. After you turn on patterns, you still have to program and select a pattern (A or B), as described in the next sections, before the patterns feature is active. If you turn off the patterns feature, your pump will automatically select your standard basal pattern.

1. Go to the PATTERNS OPTION screen.  
**Main > Basal > Basal Setup > Patterns**
2. Select **On**, then press **ACT**. The patterns feature is now on. Exit the menus.

**To turn basal patterns on, do these steps:**

### Programming a pattern

Your pump will keep your pattern settings even when the Patterns option is turned off. However, the patterns feature must be on to program a basal pattern.

**To program your patterns, do these steps:**

1. Go to the EDIT BASAL screen.  
**Main > Basal > Basal Setup > Set/Edit Basal**
2. Select the basal pattern you want to program, then press **ACT**.

3. The SET BASAL RATE 1 screen appears. The basal rate flashes, indicating that it can be changed. Set your first rate, then press **ACT**.  
The start time for your first basal rate is midnight and cannot be changed.
4. The SET START TIME 2 screen appears. The dashes under the screen name flash. The first basal rate is now set.  
If you want to use the same rate for the whole day, press **ESC** and skip to step 10. If you want to program another basal rate, follow steps 5 through 8.
5. In the SET START TIME 2 screen enter the time of the day you want this basal rate to become active.
6. Press **ACT**. The SET BASAL RATE 2 screen appears.
7. The previously set basal rate or dashes flash on the screen. Select the value for this basal rate.
8. Press **ACT**. The SET START TIME 3 screen appears. The second basal rate is now set.
9. If you do not need to set up any more basal rates, press **ESC**. If you need to set up more basal rates, repeat steps 5 through 8 above for each rate.
10. After you press **ESC**, the BASAL RATE screen appears. The screen will show:
  - the current basal pattern and basal rate,
  - time it started, and
  - the 24-hour basal total.

After you make changes to a pattern, the pump will use that pattern as the current basal. Make sure the basal you want is selected in the SELECT PATTERN screen.

### Select a pattern

Before you select a pattern to be active, make sure the Patterns feature is turned on. After your standard pattern or pattern A or B are set, do these steps to select a pattern to be the active one:

#### To select a pattern, do these steps:

1. Go to the SELECT PATTERN screen.

Main > Basal > Select Patterns

2. Select the desired pattern, then press **ACT**.
3. The screen will return to the BASAL MENU. Your basal pattern is now active. Exit the menus.



**Note:** If pattern A or B is active, the pump is in Special mode. An open circle appears at the top of the screen.

### **Example 1:** **Basal patterns**

Ken has had his insulin pump for about a month. He tests his blood glucose 4–6 times a day and records his results in his logbook. He is happy with his glucose control during the week but on the weekends, he noticed that he has to eat more food to prevent his blood glucose from running too low.

Ken has realized that during the week while he is at work, he is very inactive and sits at a desk most of the time. On the weekends, though, he is busy with yard work, running errands and playing with his kids. He determines that he needs to have lower basal settings to receive less insulin during active times, such as his weekend.

He can use the Basal Patterns feature to support his weekend change in activity. During the week, he can set his pump to deliver in the standard setting, and on Saturday morning, he can switch over to Pattern A, which he can set with lower basal rates for the weekend. On Monday morning, he can return his pump to the Standard setting for his weekday insulin needs.

### **Example 2:** **Basal patterns**

Cynthia has had diabetes for about 12 years and has been on her pump for several weeks. Every Monday, Wednesday and Friday, Cynthia goes on a 2 mile walk in the morning. To prevent hypoglycemia on these days, she uses the patterns feature. For those days, she simply switches over to Pattern A, which she has programmed with a lower set of basal rates. Before she learned to use the patterns feature, she would have to eat more food throughout the day to keep her blood glucose at a safe level. Cynthia has also noticed that a few days prior to menstruation, her



blood glucose levels seem to rise, requiring more insulin. She has programmed Pattern B on her pump with higher basal rates for this time. For her usual schedule, she uses the standard basal pattern.

### Your turn:

Can you think of situations where you might require different basal rate settings on different days?

## Temp basal rates

This feature is useful to manage blood glucose levels during **unusual** short-term activities or conditions. These conditions could be an illness or physical activity.

A temporary basal rate allows an immediate short-term change to your basal insulin for a specified period of time (30 minutes to 24 hours). This rate can be up to your Maximum basal rate setting. It offers an easy way to immediately meet short-term insulin needs for temporary activities or situations. When your blood glucose is temporarily high or low, a temp basal rate allows you to set a temporarily higher or lower basal to accommodate your blood glucose. For ongoing periods of increased or decreased activity, the patterns feature may be more suitable.

### How does temp basal work?

During a temp basal delivery, all other basal programming is temporarily overridden. After the temp basal delivery is completed, your pump will return to the programmed basal. A temp basal is delivered only once and does not repeat. If you want another temp basal, you must program the temp basal again. This feature may be useful to temporarily increase or decrease basal insulin during illness, exercise or similar unusual situations.

### Temp basal types

Based on your preference, you can select either Percent of Basal or Insulin Rate.

## Insulin rate (U/H)

Insulin rate is a fixed basal in units per hour (U/H). This temp basal type is independent of your current basal. When you select **Insulin rate (U/H)** for your temp basal type, your pump will deliver the fixed amount you have set for the duration as set. The amount of your temp basal insulin rate can be set up to your Maximum basal rate setting.

If you make changes to your normal basal rate, your U/H temp basal is not affected and will continue to deliver as programmed.

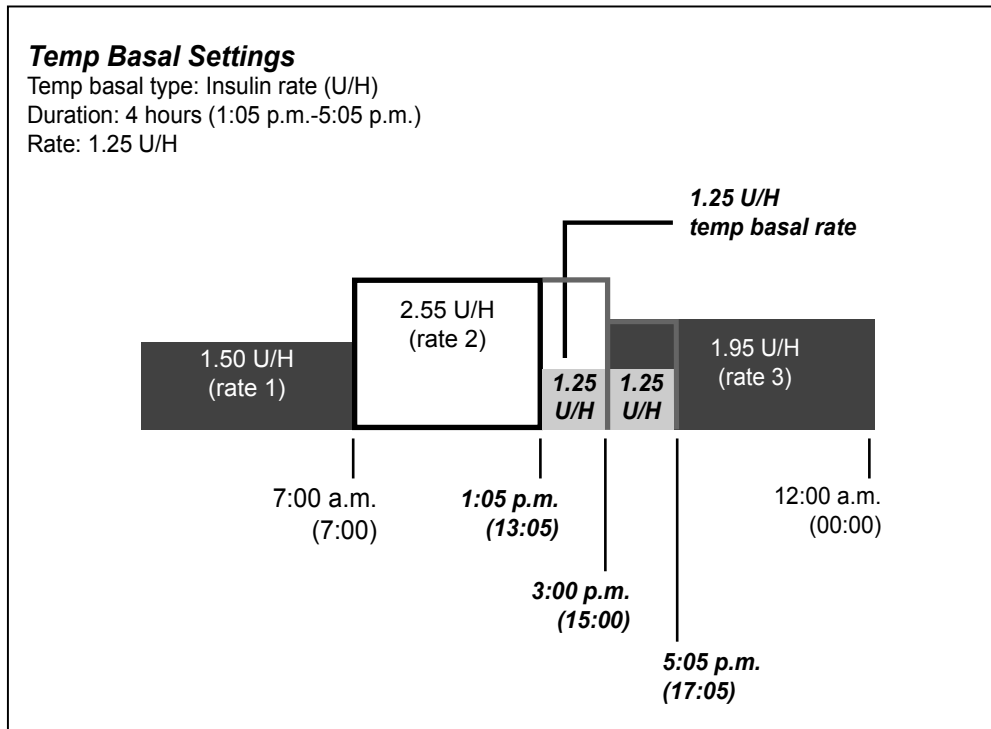

## Percent of basal

Unlike insulin rate, the percent of basal is dependent on your current basal rates. Percent temp basal is a percentage of your current basal (0–200 percent limited to your Maximum basal rate setting). The temp basal amount is rounded down to the next 0.025 or 0.05 U/H increment based on the basal rate.

The maximum percent limit is based on the largest basal rate segment with your programmed temp basal rate time.

**For example:** It is 6:00 AM and your current basal rate is 1.50 U/H. You want to set a temp basal rate of 130 percent for seven hours. The maximum percent temp basal rate you can set is 125 percent. Anything larger would make #2 segment exceed your Maximum basal setting of 2.0 U/H.

<b>Your current basal rates:</b>	<b>Your Maximum basal rate setting: 2.0 U/H</b>
Segment #1: 12:00A	1.50 U/H
Segment #2: 11:00A	1.60 U/H (largest)
Segment #3: 4:00P	1.30 U/H

If your current basal changes (for example, from rate 1 to rate 2), your percent temp basal amount will also change. The pump will deliver the percentage for the duration that you have set.

You cannot make changes to your normal basal rate while a percent temp basal is active. You must either wait until the temp basal is finished or cancel the temp basal in order to reprogram your normal basal rate setting(s).

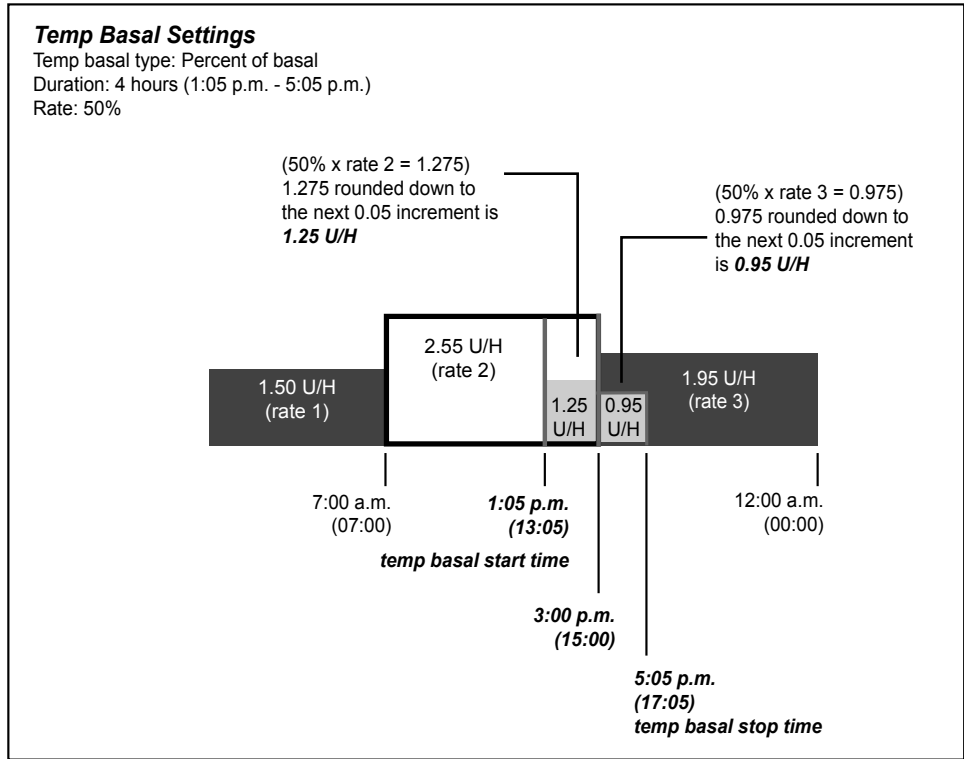

## Selecting temp basal type

Your pump will remember the temp basal type setting. Once the type is set, you do not have to set it again. To select a temp basal type, do these steps:

1. Go to the SET TEMP BASAL AS screen.  
**Main > Basal > Basal Setup > Temp Basal Type**
2. The SET TEMP BASAL AS screen appears. Select **Insulin Rate (U/H)** or **Percent of Basal**, then press **ACT**.
3. The screen will return to the BASAL SETUP screen. The temp basal type is now set. Exit the menus.

If you select **Percent of Basal** as your temp basal type, changes to your basal rate are not allowed until after temp basal is completed or cancelled.

## Delivering a temp basal

A temp basal cannot exceed your programmed Max basal rate.

1. Go to the BASAL MENU.  
**Main > Basal**
2. Select **Set/Edit Temp Basal**, then press **ACT**.
3. The SET DURATION screen appears. The duration will flash. Duration is the amount of time it will take for the pump to deliver the temporary basal. Enter the desired minutes or hours (30 minutes to 24 hours), then press **ACT**.
4. If you have selected insulin rate as your temp basal type, the SET TEMP BASAL U/H screen appears. If you have selected percent of basal as your temp basal type, the SET TEMP BASAL % screen appears. The temporary basal rate will flash. Enter your temp basal rate, then press **ACT**.
5. The BASAL MENU screen appears with an open circle at the top of the screen. Your pump is in Special mode; temp basal is now set and delivering. Exit the menus.

### Verifying temp basal delivery

Temporary basal information is available in the STATUS screen only.

During a temporary (temp) basal, the pump is in Special mode (an open circle appears). This open circle will remind you that a temp basal is active. Additionally, your pump will beep/vibrate three times on the hour regardless of the starting/ending time for the temp basal. During delivery, go to the STATUS screen to see the current temp basal information.

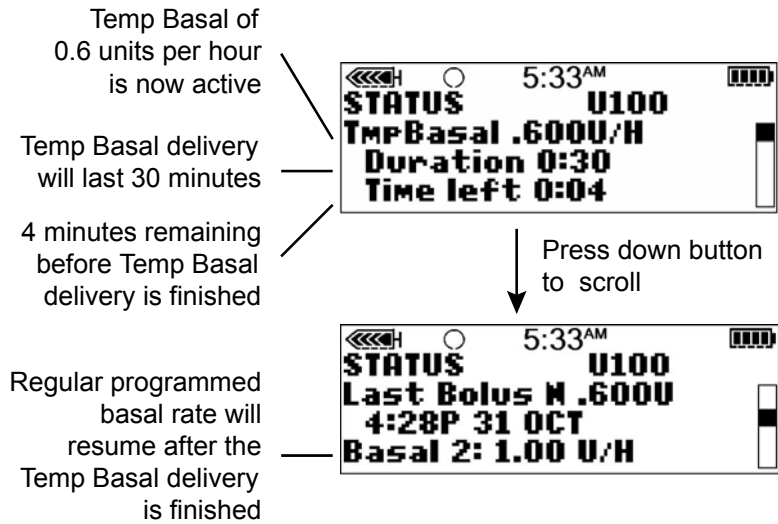

## Canceling a temp basal

Use the Cancel Temp Basal function in the BASAL MENU to cancel a temporary basal. This function immediately stops the temp basal and resumes the regular programmed basal delivery.

### To cancel a temp basal, do these steps:

1. Go to the BASAL MENU.  
Main > Basal
2. Select **Cancel Temp Basal**, then press **ACT**.

The screen will return to the BASAL MENU. Your temp basal is cancelled and open circle has disappeared from the top of the screen. The programmed basal is now active again. Exit the menus.

### Example 1:

#### Temp Basal for a decreased temporary basal rate

Ramon and his friends got together for an unplanned game of soccer. Before using the pump, he was taking shots to manage his diabetes. Ramon experienced frequent low blood glucose reactions sometimes during, and very often after, he played games with his friends. Now that he is using his pump, he can use the

Temporary Basal Rate feature to help prevent low blood glucose. He simply programs his pump to temporarily deliver less basal insulin during the time that he is playing, and often for several hours after play, as well.

Ramon was able to determine how to set his Temporary Basal rates by frequent blood glucose testing, both during and after activity, and recording his results. The first time he tried using the pump, his healthcare professional had him program his pump to deliver one-half of his usual basal rate for the amount of time that he was playing and for an hour after he was done. After consulting with his healthcare professional, Ramon made small adjustments to the temporary basal rate and the duration of time each time he tried to use the feature. After several different attempts with similar activity for the same amount of time, (such as his soccer game that lasted two hours), he found a temporary basal rate that worked well for him.

**Example 2:**

**Temp Basal for an increased temporary basal rate**

Gail has had a cold with a cough for a couple of days. Because she is not feeling well, she tests her blood glucose more frequently. She finds that her blood glucose levels are running above target range before meals and she has needed several correction boluses to keep her blood glucose levels within her normal limits. After consulting with her healthcare professional, Gail uses the Temporary Basal Rate to increase her basal rate during the day today. As prescribed by her healthcare professional, Gail checks her blood glucose more frequently until she is feeling well.

**Your turn:**

Think of an activity where you might need to use a Temporary Basal Rate.

At what rate is your current basal rate running? \_\_\_\_\_

What Temporary Basal Rate would you try using at this time?

\_\_\_\_\_

How long will you be active?\_\_\_\_\_

What duration will you set for the Temporary Basal Rate?\_\_\_\_\_

Test your blood glucose before and during activity and several times after as well.  
What are your blood glucose results?

Pre-activity\_\_\_\_\_

During activity\_\_\_\_\_

1 hour after activity\_\_\_\_\_

Several hours after activity\_\_\_\_\_

What Temporary Basal Rate changes will you make for the next time you try this?



■ sensor features



7



# 7

## Sensor features

The sensor feature on your system lets you integrate and use continuous glucose monitoring. Continuous glucose monitoring is a monitoring tool that uses a glucose sensor that is placed below your skin to continuously measure the amount of glucose in your interstitial fluid. Calibrate the sensor three to four times a day to improve accuracy. Continuous glucose monitoring can help you better manage your diabetes by:

- Recording your glucose levels more often throughout the day and night.
- Showing the effects that your diet, exercise, and medication can have on your glucose levels.
- Giving you additional tools to help you prevent high and low glucose levels.



**WARNING: Do not make therapy treatment decisions based on sensor glucose values because sensor glucose and blood glucose values may differ. If your sensor glucose reading is low or high or if you feel symptoms of low or high glucose, confirm your blood glucose with your BG meter prior to making therapy decisions to avoid severe low or high glucose conditions.**

To learn more about the accuracy of sensor glucose (SG) readings versus blood glucose (BG) readings, see the *Enlite™ Sensor Performance for the MiniMed® 530G Insulin Pump* information.

To take advantage of the continuous glucose monitoring features on your MiniMed 530G system, call 800 646 4633, +1 818 362 5958 (outside U.S.), or visit our web site at [www.medtronicdiabetes.com](http://www.medtronicdiabetes.com) to purchase your Enlite sensor and transmitter.

## Setting up continuous glucose monitoring

To use the sensor feature on your pump, you must complete the following steps in order:

- Charge the transmitter.
- Enter your sensor settings into your pump, as prescribed by your healthcare professional.
- Insert the Enlite sensor, apply the Enlite overtape, and then wait five minutes.
- Connect the transmitter to the sensor.
- Prepare the sensor for communication and then wait two hours.
- Enter your first meter BG.

## About Threshold Suspend

This section must be read before using the Threshold Suspend feature.

Threshold Suspend is an independent CGM feature designed to automatically stop insulin delivery when your sensor value reaches or falls below the Suspend Threshold that you have set. The Suspend Threshold can be set based on your individual needs (60 – 90 mg/dL). Your healthcare provider will determine if this feature is right for you.

Remember, as with all of the sensor features, your sensor needs to be calibrated every 12 hours in order for this feature to work.

## How Threshold Suspend works

When your sensor glucose reaches or drops below the Suspend Threshold you have set, the pump sounds an alarm, stops all insulin delivery, and displays THRESH SUSPEND on the screen. When this occurs, you can choose to:

- Clear the Threshold Suspend alarm and select continue to suspend all insulin delivery for two hours from the time that the alarm first occurred.

- Clear the Threshold Suspend alarm and select restart basal insulin delivery. If a temporary basal rate was delivering at the time of suspension, then that basal rate will restart. A bolus will not restart.

However, if you do not clear the Threshold Suspend alarm, the following will occur:

- The Threshold Suspend alarm continues to siren.
- Insulin delivery remains suspended for two hours.
- Your pump screen displays an emergency message after two minutes.

If you do not respond to the Threshold Suspend alarm after two hours of suspension, basal delivery will restart, regardless of your sensor glucose value. However, only your standard basal or basal pattern will restart. If you had a temporary basal rate set or a bolus, they will not restart.

Example: The Threshold Suspend alarm goes off, you do not respond and your insulin suspends. Ninety minutes later you respond, check your BG, choose to continue to suspend, and treat your low BG. The pump stays suspended for 30 more minutes, for a total of two hours, then basal insulin delivery resumes. Threshold Suspend will alarm and suspend insulin delivery again if your SG remains below or reaches your Suspend Threshold after your set Low Repeat time has been reached. You can either choose to Suspend again or Restart Basal.

Once basal delivery has restarted, if after 4 hours your sensor glucose value is at or below your Suspend Threshold, the pump suspends insulin delivery again for an additional 2 hours. Keep in mind that if you do not respond, the alarm continues to siren during this entire period.

The only other setting required to use threshold suspend is the Low Repeat, which is set to 20 minutes by default (but can be set from 5 to 60 minutes). Once you have cleared a Threshold Suspend alarm and basal insulin is delivering, the Low Repeat determines the amount of time that will pass before you will receive the Threshold Suspend alarm again.

For example, when the Low Repeat is set at 20 minutes, after clearing the Threshold Suspend alarm and once basal insulin is delivering, you will receive another Threshold Suspend alarm 20 minutes later, as long as your sensor glucose is still at or below your SUSPEND THRESHOLD. Once your sensor glucose is above

your SUSPEND THRESHOLD, the THRESHOLD SUSPEND does not occur again. If a different time setting for repeating the THRESHOLD SUSPEND is desired, you will need to change your low repeat time.

## Threshold Suspend Examples

The examples cover the following:

- Example 1: No response to Threshold Suspend
- Example 2: Respond to Threshold Suspend Alarm within 2 hours and select Suspend option
- Example 3: No response during a 2 hour suspend and then responds during 4 hour basal resume
- Example 4: Respond to Threshold Suspend within 2 hours and select Restart Basal option
- Example 5: Continuing Threshold Suspend without testing



**Note:** During the Threshold Suspend siren you can press any button to silence your pump for two minutes. The temporary silencing of the alarm does not affect the suspension or delivery of insulin.

### Example 1: No response to Threshold Suspend

Anna is retired and lives alone. At 2am her pump sounded a Threshold Suspend siren and suspended insulin delivery. Anna did not respond to the alarm which continued to siren, until she woke up at 8am. She cleared the alarm by pressing **ESC**, then **ACT**. She also saw that her basal insulin had restarted.

Anna realized that her pump had automatically suspended insulin delivery for 2 hours, and then automatically restarted her basal insulin when she had not responded after two hours of suspension. She then checked her blood glucose with her BG meter and acted appropriately according to her blood glucose value.

Anna knows that once her basal delivery had restarted, if after 4 hours her sensor glucose value was at or below her Suspend Threshold, her pump would have suspended insulin delivery again for two hours if she did not respond.



**Note:** If you do not respond, this Threshold Suspend sequence will continue as long as your sensor calibrations are current and the pump battery has power. Calibration must be done a minimum of every 12 hours. For calibration guidelines, see *Calibrating the sensor, on page 145*.

For more information about how to respond to a Threshold Suspend alarm, see *THRESH SUSPEND (THRESHOLD SUSPEND), on page 208*.

### **Example 2: Respond to Threshold Suspend Alarm within 2 hours and select Suspend option**

Dave is 75 years old and lives with his daughter. He has been experiencing some low sensor glucose values. Dave's doctor has recommended he use the Threshold Suspend feature. It is now 1 am and Dave's sensor value has fallen to his Suspend Threshold of 60 mg/dL. His daughter is awakened by the Threshold Suspend siren. She clears the alarm/siren by pressing **ESC**, then **ACT** buttons and selects to continue to Suspend. His daughter checks Dave's finger stick, confirming his low blood glucose and provides Dave with carbohydrates to treat the low blood glucose.

Dave's daughter continues to monitor his blood glucose while the pump is in the 2-hour Threshold Suspend period. Once she sees that Dave's blood glucose is stable and back within blood glucose target range, she restarts his basal by pressing **ESC**, then **ACT**.

Dave's daughter knows that if his sensor value reaches or falls below the Suspend Threshold again, after his Low Repeat time has passed, the pump will once again suspend his insulin delivery for two hours and the pump will siren.

For more information about how to respond to a Threshold Suspend alarm, see *THRESH SUSPEND (THRESHOLD SUSPEND), on page 208*.

### **Example 3: No response during a 2 hour suspend and then responds during 4 hour basal resume**

Michael is on his college hockey team. He played in a hockey tournament all day and is so exhausted that he falls asleep in front of his television, when his glucose begins to drop. When his sensor value falls to his Suspend Threshold, the pump begins to siren and immediately suspends all insulin delivery. Michael does not respond to his alarm.

About three hours later, his roommate comes home, hears the pump siren and wakes up Michael. Michael clears the siren/alarm by pressing **ESC**, then **ACT** buttons and sees that his basal insulin has automatically been restarted after a two hour suspend. He checks his blood glucose and acts appropriately according to his blood glucose value.

Michael knows that if his sensor value reaches or falls below his Suspend Threshold again, after his Low Repeat time has passed, then the pump will suspend insulin delivery and siren again.

For more information about how to respond to a Threshold Suspend alarm, see *THRESH SUSPEND (THRESHOLD SUSPEND)*, on page 208.

#### **Example 4: Respond to Threshold Suspend within 2 hours and select Restart Basal option**

Maria's Low Glucose Limit is set at 70 mg/dL, Threshold Suspend set at 60 mg/dL, and Low Repeat set to 20 minutes. While at work, Maria's pump alerts her with a Low SG that her sensor glucose has reached 70 mg/dL. She confirms her BG with a meter and treats the low according to her healthcare professional's instructions. A few minutes later, her pump begins to siren with a Threshold Suspend alarm when her sensor glucose reaches 60 mg/dL. Maria knows that she already treated her confirmed low BG and that it will take a few more minutes to rise. She clears the Threshold Suspend alarm by pressing **ESC**, then **ACT** buttons and selects **RESTART BASAL**. If Maria's sensor glucose remains or falls below 60 mg/dL again after 20 minutes (Low Repeat time) then, her pump will again suspend insulin delivery for two hours.

For more information about how to respond to a Threshold Suspend alarm, see *THRESH SUSPEND (THRESHOLD SUSPEND)*, on page 208.

#### **Example 5: Continuing Threshold Suspend without testing**

Mark lives alone. While asleep, his pump sirens with a Threshold Suspend alarm and insulin delivery suspends. The alarm wakes him and he chooses to continue to suspend by pressing **ESC**, then **ACT** buttons and selecting to continue to Suspend. He then goes back to sleep without checking his blood glucose even though he has been taught by his Healthcare Professional to always test his blood sugar when the Threshold Suspend alarm sounds.



After Mark's pump has been suspended for two hours, basal insulin delivery automatically resumes. Twenty minutes after the pump resumes basal insulin delivery (which is Mark's Low Repeat time), Mark's SG is still below his Suspend Threshold. His pump again sirens and insulin delivery is suspended. This time Mark does not respond to this alarm and the pump remains suspended for an additional two hours. By not checking his blood glucose when he was aware of the alarm, Mark has missed the opportunity to appropriately address his blood glucose. If the SG was correctly reflecting Mark's BG, turning off the pump may not have been sufficient to address hypoglycemia (carbohydrates may have been needed) and Mark's blood glucose may have gone lower. If the SG did not correctly reflect Mark's BG and was above the Threshold, Mark is now at risk for hyperglycemia and ketosis as he only received insulin for 20 minutes during a period of 4 hours and 20 minutes.





**Note:** Responding to the Threshold Suspend alarm enables the Low Repeat function. If you choose to suspend insulin for 2 hours, the pump will suspend again for another 2 hours after the low repeat time if the sensor glucose is at or below your suspend threshold level. You should always respond to alarms when possible and check your blood glucose to avoid the risk of severe hypoglycemia or hyperglycemia with ketosis.

For more information about how to respond to a Threshold Suspend alarm, see *THRESH SUSPEND (THRESHOLD SUSPEND)*, on page 208.

## Charging the transmitter

For details on how to charge your transmitter, see the transmitter or charger user guide.

## Entering your sensor settings

Enter your pump sensor settings in the order they appear below, as some of the settings are dependent upon other settings being made first. When you complete each setting, your pump will automatically display the screen for the next setting in the sequence. When a screen item flashes, you may change the value of the flashing item by pressing  or .

## Turning on the sensor

The sensor must be turned on, started and initialized to report glucose measurements.

1. Go to the EDIT SETTINGS screen.

**Main > Sensor > Edit Settings**

The EDIT SETTINGS screen appears with **Sensor: Off** selected.

2. Press **ACT**. The SENSOR ON/OFF screen appears.
3. Select **On**, then press **ACT**. The EDIT SETTINGS screen appears showing the sensor is now turned **on**.

You are now ready to turn on the glucose alerts.

## Turning on the Glucose Alerts

The Glucose alerts must be turned on if you want the system to send you an alert when the sensor glucose measurements reach or exceed your Glucose Limits. For a Low sensor glucose alert, the pump plays four consecutive tones, in falling pitch, if an audible beep has been selected as the alert type. For a High sensor glucose alert, the pump plays four consecutive tones, in rising pitch, if an audible beep has been selected as the alert type.

1. Make sure the EDIT SETTINGS screen is open.

**Main > Sensor > Edit Settings**

2. Select **Glucose Alerts**, then press **ACT**. The GLUCOSE ALERTS screen appears.
3. Select **On**, then press **ACT**. The EDIT SETTINGS screen appears showing the glucose alerts are now turned **On**.

## Setting the Glucose Limits

If you turned the Glucose alerts **On**, then you need to set the high and low Glucose Limits prescribed by your healthcare professional. Your prescribed glucose limits may vary throughout the day, so your pump allows you to set up to eight pairs.

A Glucose Limit pair includes one High Glucose Limit and one Low Glucose Limit, as shown in the following table:

Glucose Limit pair	Alerts
<b>Low:</b> 80 mg/dL	A <b>Low Glucose Limit</b> alert occurs when the sensor glucose measurement <b>reaches or goes below</b> the Low Glucose Limit in this table.
<b>High:</b> 240 mg/dL	A <b>High Glucose Limit</b> alert occurs when the sensor glucose measurement <b>reaches or goes above</b> the High Glucose Limit in this table.

### Setting the Glucose Limits start time

If your healthcare professional prescribes more than one pair of Glucose Limits, you must enter a start time for each. For example, you may use one pair of Glucose Limits during the day and another pair at night. The example below shows two pairs of Glucose Limits. The first pair begins at midnight, and the second pair begins at 9:00 AM.

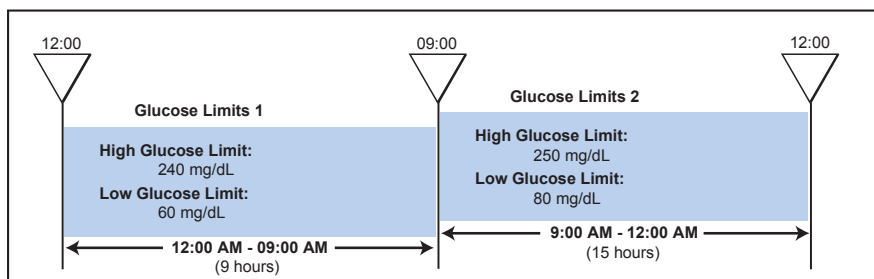

#### To set up your Glucose Limits:

- Make sure the EDIT SETTINGS screen is open.  
Main > Sensor > Edit Settings
- Select **Glucose Limits**, then press **ACT**. The SET GLUCOSE LIMITS 1 screen appears. The Low Glucose Limit flashes 80 mg/dL.  
The start time for your first pair of Glucose Limits is midnight and cannot be changed.
- Select your Low Glucose Limit. The value must be between 40 and 390 mg/dL. To switch off the Low Glucose Limit, reduce it below 40 mg/dL to select **OFF**.

4. Press **ACT** to select your High Glucose Limit. The screen flashes 240 mg/dL. The limit you select must be between 50 and 400 mg/dL. Your High Glucose Limit must also be at least 10 mg/dL above your Low Glucose Limit. To switch off the High Glucose Limit, reduce the High Glucose Limit below 50 mg/dL to select **OFF**.
5. Press **ACT**. The SET START TIME 2 screen appears. The dashes under the screen name flash. The first pair of Glucose Limits is now set.  
If you do not need a second pair of Glucose Limits, press **ESC** and skip to the next section. If you want to set up a second pair of Glucose Limits, follow steps 6 through 11 below.
6. To set a second pair of Glucose Limits, select the time of day you want this pair to become active.
7. Press **ACT**. The SET GLUCOSE LIMITS 2 screen appears. The default Low Glucose Limit flashes (**OFF**).
8. Select your Low Glucose Limit. The value must be between 40 and 390 mg/dL.
9. Press **ACT**. The default High Glucose Limit flashes (**OFF**).
10. Select your High Glucose Limit. The value must be between 50 and 400 mg/dL.
11. Press **ACT**. The SET START TIME 3 screen appears.  
The second pair of Glucose Limits (Glucose Limits 2) is now set. If you do not need any more Glucose Limits pairs, press **ESC**. If you want to set more Glucose Limits, then repeat steps 6 through 11 above for each pair, up to a maximum of eight.

You are ready to set up your High Repeat.

## Setting the High Repeat

After you receive and clear a High Glucose, Rise Rate of Change, or High Predictive alert, the alert will repeat until the condition that has caused the alert is resolved. The High Repeat feature allows you to set how frequently you want the alert to repeat after you clear it the first time. For example, if your blood glucose levels usually take one to two hours to fall after a correction bolus, you may want to set the High Repeat to one or two hours to avoid unnecessary alerts.

For example, you set your High Repeat to 15 minutes. You receive an alert at 1:00 PM and immediately clear it. However, the condition that caused the alert still exists, so you will receive a second alert at 1:15 PM, 15 minutes after you cleared the first alert. If you immediately clear the alert again, then the alert will repeat at 1:30 PM and continue to repeat every 15 minutes until you resolve the condition that caused the alert. (This example also applies to the Low Repeat.)

### To set up your High Repeat:

1. Make sure the EDIT SETTINGS screen is open.  
**Main > Sensor > Edit Settings**
2. Select **Hi Repeat**, then press **ACT**. The SET HI ALERT REPEAT screen flashes the default High Repeat time of 1 hour (1:00).
3. Select your High Repeat time. The time must be between 5 minutes (0:05) and 3 hours (3:00).
4. Press **ACT**. The EDIT SETTINGS screen shows the High Repeat value set.  
 You are now ready to set up your Low Repeat.

### Setting the Low Repeat

After you receive and clear a Low Glucose, Fall Rate of Change, or Low Predictive alert, the alert will repeat until the condition that caused the alert is resolved. The Low Repeat feature allows you to set how frequently you want the above alerts to repeat after you clear it the first time. The Low Repeat is also used for the Threshold Suspend alarm when the patient clears the alarm. Once basal insulin is restarted, then the pump will not suspend again until the sensor glucose value has reached or fallen below the Suspend Threshold and the programmed Low Repeat time has passed. Please see the *Alarms and alerts* chapter for more information on Threshold Suspend. The Low Repeat feature works similar to the High Repeat one. See *Setting the High Repeat* section in this chapter for an example.

1. Make sure the EDIT SETTINGS screen is open.  
**Main > Sensor > Edit Settings**
2. Select **Lo Repeat**, then press **ACT**. The SET LO ALERT REPEAT screen flashes the default Lo Alert Repeat time of 20 minutes (0:20).
3. Select your Low Repeat time. The time must be between 5 minutes (0:05) and 1 hour (1:00).

4. Press **ACT**. The EDIT SETTINGS screen shows the Low Repeat value set.  
You are now ready to set up the Predictive Alert.

## Setting the Predictive glucose alert

The Predictive alerts calculate when you may reach your Low or High Glucose Limits, then send you an alert before you reach those limits. A Predictive alert tells you that **if your sensor glucose measurements keep falling or rising at the current rate**, you may reach your Glucose Limit in the number of minutes you selected. For a LOW PREDICTED alert, the pump plays three consecutive tones, in falling pitch, if an audible beep has been selected as the alert type. For a HIGH PREDICTED alert, the pump plays three consecutive tones, in rising pitch, if an audible beep has been selected as the alert type.

## Understanding the Time Sensitivity Settings

To use the Predictive alerts, you need to first set your Low or High Glucose Limits, and then your Time Sensitivities. Time Sensitivity means the length of time, in minutes, you want to be notified before you reach your High or Low Glucose Limit. If you set the Low time sensitivity setting at 25 minutes and the High time sensitivity setting at 20 minutes, then the Predictive alerts will be sent:

- 25 minutes **before** the sensor glucose reaches your Low Glucose Limit
- 20 minutes **before** the sensor glucose reaches your High Glucose Limit

### To set up the Predictive alerts:



1. Make sure the EDIT SETTINGS screen is open.  
**Main > Sensor > Edit Settings**
2. Select **Predict Alerts**, then press **ACT**. The PREDICTIVE ALERTS LOW/HIGH screen shows that the alerts are turned **Off**.
3. Select **On**, then press **ACT**. The SET TIME SENSITIVITY LOW/HIGH screen appears and the LOW time setting flashes the default time: 15 minutes (0:15).
4. Select the Time Sensitivity (how many minutes before you reach your Low Glucose Limit). To turn off the Low Predictive Alert, reduce the Time Sensitivity to **OFF**.
  - Range: **5 to 30 minutes (0:05 to 0:30)**
  - Increments: **5 minutes**

5. Press **ACT**. The HIGH time setting flashes the default time: 15 minutes (0:15).
6. Select the Time Sensitivity (how many minutes before you reach your High Glucose Limit). To turn off the High Predictive Alert, reduce the Time Sensitivity to **OFF**.
  - Range: **5 to 30 minutes (0:05 to 0:30)**
  - Increments: **5 minutes**
7. Press **ACT**. The EDIT SETTINGS screen appears.  
You are now ready to set up the rate alerts.

### Setting the Rate of Change Alerts

The Rate of Change alerts tell you when your sensor glucose (SG) changes at, or faster than, the per-minute rate pre-selected by you. There are two alerts:

- **FALL RATE** for SG **decreases** at or faster than your pre-selected rate. The pump plays two consecutive tones, in falling pitch, if an audible beep has been selected as the alert type.
- **RISE RATE** for SG **increases** at or faster than your pre-selected rate. The pump plays two consecutive tones, in rising pitch, if an audible beep has been selected as the alert type.

You can set one or both Rate of Change alerts. The rate of change alert default setting is **OFF**. When you press  or , 4.0 mg/dL displays. This value changes up or down with each additional press.

The explanation in the following table shows how the Rate alerts work.

If you set the number	Then
Lower than 4.0 mg/dL/min	<ul style="list-style-type: none"> <li>• The system is <b>more sensitive</b> to SG changes</li> <li>• Alerts are <b>more frequent</b> than if you use a higher number</li> </ul>
Higher than 4.0 mg/dL/min	<ul style="list-style-type: none"> <li>• The system is <b>less sensitive</b> to SG changes</li> <li>• Alerts are <b>less frequent</b> than if you use a lower number</li> </ul>

### To set up the Rate of Change alerts:

1. Make sure the EDIT SETTINGS screen is open.  
**Main > Sensor > Edit Settings**

2. Select **Rate Alerts**, then press **ACT**. The SET FALL RATE LIMIT screen flashes the rate alert default setting: **OFF**.
3. Select the Fall Rate Limit.
  - Range: mg/dL/min from **1.1** to **5.0**
  - Increments: mg/dL/min **0.1**
4. Press **ACT**. The SET RISE RATE LIMIT screen flashes the rate alert default setting: **OFF**.
5. Select the Rise Rate Limit. The range and increments are the same as the Fall Rate Limit (see step 3 above).
6. Press **ACT**. The Rate of Change alerts will now use the settings you specified. You are now ready to set up the Cal Repeat.

### Setting the Threshold Suspend



**WARNING: Do not rely on the Threshold Suspend feature to prevent or treat your low blood glucose. Always confirm your blood glucose reading with your BG meter if you are able. Treat a confirmed low blood glucose according to instructions from your healthcare professional. If you are unable to respond to the Threshold Suspend alarm, the pump will remain suspended for two hours unless you resume insulin delivery earlier.**

Threshold Suspend (THRESH SUSPEND) is an optional feature that suspends insulin delivery when your sensor glucose value reaches or falls below the Suspend Threshold that you set. This feature is for situations when you cannot respond to a low glucose condition. Threshold Suspend will only work if your calibrations are current and you have sensor glucose values available.





**WARNING:** Threshold Suspend uses the sensor glucose value, not your blood glucose value, to automatically suspend your pump. Your pump may automatically suspend when your sensor glucose is at or below the Suspend Threshold, while your blood glucose is above that limit. This could result in hyperglycemia. Likewise, your pump may not suspend even though your blood glucose is at or below the Suspend Threshold. This could result in hypoglycemia. Always check your blood glucose and treat as appropriate.

When the Threshold Suspend alarm is triggered, the THRESH SUSPEND message is displayed, a siren will sound, and all insulin delivery is stopped. A solid circle (alarm icon) will be displayed on your pump screen to indicate that insulin delivery is suspended. After you clear the alarm, you are given the option to either continue to suspend basal delivery or restart your basal insulin.

If the alarm is not cleared, the siren will continue to sound, insulin delivery will stay suspended, and your pump screen will display an emergency message. After basal insulin delivery has been suspended for two hours, the pump will automatically restart basal delivery. Four hours after delivery has resumed and if your sensor glucose is still at or below the Suspend Threshold, the pump will once again suspend insulin delivery for two hours. For more information about the Threshold Suspend (THRESH SUSPEND) alarm, see *THRESH SUSPEND (THRESHOLD SUSPEND)*, on page 208.

In addition to the Threshold Suspend feature, you can set up Glucose, Predictive, or Fall Rate of Change alerts to warn you about low or falling glucose values.

The default setting for the Threshold Suspend feature is OFF. Consult your healthcare professional for the Threshold Suspend setting that is best for you.

### **To set up the Threshold Suspend feature:**

1. Make sure the EDIT SETTINGS screen is open.  
**Main > Sensor > Edit Settings**
2. Select **Thresh. Suspend**, and then press **ACT**. The THRESHOLD SUSPEND screen appears.
3. Select **On**, then press **ACT**.

4. The **SET SUSPEND THRESHOLD** screen flashes the default Suspend Threshold of 60 mg/dL. Select your limit. You should set the Suspend Threshold to a value that is less than your Low Glucose limit. The limit you select must be between 60 to 90 mg/dL.
5. Press **ACT**. The EDIT SETTINGS screen shows the Suspend Threshold value set. You are now ready to set up the Cal Repeat.

## Setting the Cal Repeat

After you receive and clear a METER BG NOW alert, the device will repeat the alert until you enter a new meter blood glucose measurement. The Cal Repeat feature allows you to set how frequently you want the alert to repeat after you clear it.

1. Make sure the EDIT SETTINGS screen is open.  
**Main > Sensor > Edit Settings**
2. Select **Cal Repeat**, then press **ACT**. The SET CAL REPEAT screen flashes the default Cal Repeat time of 30 minutes (0:30).
3. Set your Cal Repeat time between 5 minutes (0:05) and 1 hour (1:00).
4. Press **ACT**. The EDIT SETTINGS screen shows the Cal Repeat time you selected. You are now ready to set your Cal Reminder.

## Setting the Cal Reminder

The Cal Reminder feature allows you to set a reminder to calibrate your system. For example, if you set your reminder to four hours, then you will receive a METER BG BY alert (Cal Reminder) four hours before the next meter blood glucose (BG) entry is due (eight hours after your last successful sensor calibration).

### To set up the Cal Reminder:

1. Make sure the EDIT SETTINGS screen is open.  
**Main > Sensor > Edit Settings**
2. Select **Cal Reminder**, then press **ACT**. The CAL REMINDER screen shows **On**.
3. Press **ACT**. The SET CAL REMINDER screen flashes the Cal Reminder default time of 1 hour (1:00).
4. Select your Cal Reminder time between 5 minutes (0:05) and 6 hours (6:00).

5. Press **ACT**. The EDIT SETTINGS screen shows the Cal Reminder time you selected. You are now ready to enter your transmitter ID number.

### Entering the transmitter ID

The transmitter ID (serial number) starts with 2 and is found on the flat side of your transmitter. You must enter the transmitter ID so that the transmitter and the pump can communicate with each other.

Write the Transmitter ID of the transmitter you are using here:

\_\_\_\_\_.

1. Make sure the EDIT SETTINGS screen is open.

**Main > Sensor > Edit Settings**

2. Select **Transmtr ID**, then press **ACT**. The SET TRANSMITTER ID screen appears. The screen shows seven dashes for the Transmitter ID, the first of which (on the left) is flashing.
3. Select the first number of the Transmitter ID (the number on the screen must match the first number of the Transmitter ID). The transmitter ID is located on the transmitter label, as shown.
4. Press **ACT**. The second dash flashes.
5. Select the next number of the Transmitter ID, then press **ACT**.
6. Repeat step 5 until all seven digits of the Transmitter ID have been selected.
7. A message shows that the Transmitter ID has been changed. After about 30 seconds, the EDIT SETTINGS screen appears. It shows the Transmitter ID you entered.

SN GT2XXXXXXX

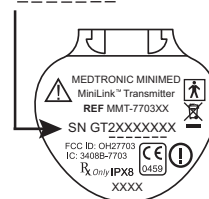

You are now ready to set up the Weak Signal.

### Setting up the Weak Signal feature

The Weak Signal feature allows you to determine how quickly you will receive a Weak Signal alert when there is no communication between the transmitter and the pump. For example, if you set the Weak Signal value to 30 minutes, you will receive a Weak Signal alert 30 minutes after loss of communication.

### To set up the Weak Signal feature:

1. Make sure the EDIT SETTINGS screen is open.  
**Main > Sensor > Edit Settings**
2. Select **Weak Signal**, then press **ACT**. The SET WEAK SIGNAL screen flashes the default time of 30 minutes (0:30).
3. Select your Weak Signal time between 5 minutes (0:05) and 40 minutes (0:40).
4. Press **ACT**. The EDIT SETTINGS screen shows the length of time you entered for the Weak Signal option.
5. You are now ready to set up the sensor glucose graph timeout.

### Setting the sensor glucose graph timeout

The sensor glucose graph timeout is how long the graphs show on the pump screen until the HOME screen automatically appears. The default timeout is two (2) minutes, and you can set it for 2, 4, or 6 minutes.

### Using a continuous graph display

You can also select **NONE** to set the sensor graph timeout to display continuously. If you select **NONE**, the sensor graphs will show until another screen or menu is selected, or an alarm/alert occurs. Selecting continuous graph display uses more battery power and decreases battery life. To return to the HOME screen from the sensor glucose graphs, press **ESC** until the HOME screen appears.

### To set the sensor glucose graph timeout:

1. Make sure the EDIT SETTINGS screen is open.  
**Main > Sensor > Edit Settings**
2. Select **Graph Timeout**, then press **ACT**. The SET GRAPH TIMEOUT screen flashes the default time of 2 minutes (0:02).
3. Select your Graph Timeout. The time you select must be: 2 minutes; 4 minutes; 6 minutes; or NONE.
4. Press **ACT**. The EDIT SETTINGS screen shows the Graph Timeout you selected.  
You are now ready to review your sensor glucose monitoring settings.

## Reviewing your settings

Use the following procedure to review your sensor settings to ensure they are set as prescribed:

1. Open the REVIEW SETTINGS screen.  
**Main > Sensor > Review Settings**
2. Press  to scroll through all settings to make sure that they are correct.
3. To change any settings, return to the EDIT SETTINGS menu.  
**Main > Sensor > Edit Settings**
4. Save your settings after you have set your preferences. This will allow you to restore the settings you have saved if you receive an alarm or error that resets your settings.

## Using the Sensor Demo

The Sensor Demo shows you a demonstration of a sensor graph. To view the Sensor Demo screen, you must first turn on the Sensor Demo feature. After the Sensor Demo feature is turned on, the first line of the STATUS and SENSOR STATUS screens will show **SENSOR DEMO: On**.



### Turning on the Sensor Demo feature

1. Make sure the EDIT SETTINGS screen is open.  
**Main > Sensor > Edit Settings**  
The EDIT SETTINGS screen shows **Sensor Demo: Off**.
2. Press **ACT**. The SENSOR DEMO ON/OFF screen appears with **Off** selected.
3. Select **On**, then press **ACT**. The EDIT SETTINGS screen shows that SENSOR DEMO is now turned **On**.



**WARNING: Do not use Sensor Demo to make any decisions related to your therapy. Information seen in the Sensor Demo is not real data. It is an example of the type of information you can access when using the sensor feature. Making treatment decisions based on data that is not real can lead to low or high blood glucose conditions.**

## Viewing the Sensor Demo screens

1. From the HOME screen, press **ESC**. The screen briefly shows SENSOR DEMO, then the first Sensor Demo graph appears.
2. You can move the cursor (flashing vertical line) through the graph to see examples of how the continuous graphs appear. Press  to move the cursor left, press  to move the cursor right.
3. You must turn the Sensor Demo off in order to show your actual, continuous sensor glucose graphs. To turn the Sensor Demo off, follow the above procedure and select **Off**.

## Inserting the Enlite sensor

Always refer to the Enlite Sertter User Guide for instructions on how to insert the Enlite sensor.

## Connecting the transmitter to the sensor

Before connecting the transmitter to the sensor, make sure of the following:

- The transmitter is fully charged.
- The transmitter ID and other sensor settings have been entered into your pump.
- The Enlite sensor has been inserted and the Enlite overtape has been applied.
- It has been at least five minutes since you inserted the sensor.
- The sensor insertion site is not bleeding.

### To connect the transmitter to the sensor:

1. Touch the rounded end of the inserted sensor to prevent it from moving during connection.

2. Hold the transmitter as shown. Line up the two notches on the transmitter with the side arms of the sensor. The flat side of the transmitter should face the skin.

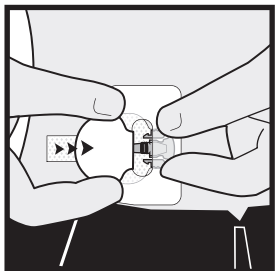

3. Slide the transmitter onto the sensor until the sensor's flexible arms snap into the notches on the transmitter. If the transmitter is properly connected, and if the sensor has had enough time to become hydrated, the green light on the transmitter will flash within 10 seconds.
4. Wait for the green light on the transmitter to flash. If the light does not flash, disconnect it from the sensor, wait for several seconds, and reconnect. If the transmitter light still does not flash, charge the transmitter.

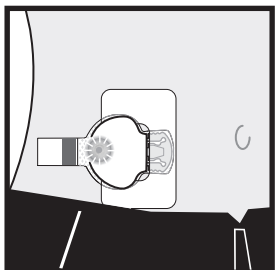

5. Cover the transmitter with the adhesive tab from the Enlite sensor.



**Caution:** Do not pull the adhesive tab on the sensor too tight across the transmitter. Doing so may prevent a proper connection between the transmitter and sensor, or may cause the sensor to pull out of your body.

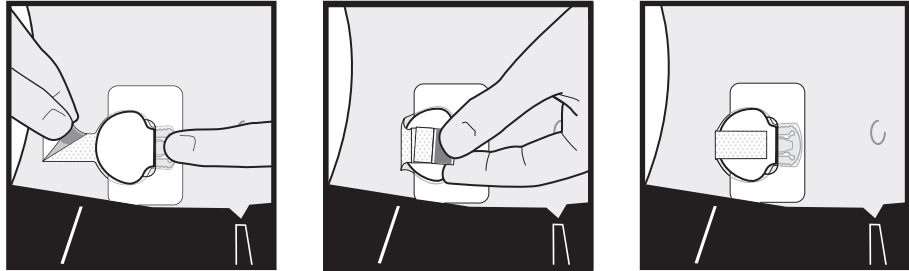

6. Follow the instructions in the next section to prepare the sensor for communication and to start sensor initialization.

## Preparing the sensor for communication

After you connect your transmitter to the sensor, the green light on the transmitter will flash. You are now ready to use your pump to start communication with the sensor and to start sensor initialization. Use your pump to follow the steps below to prepare the sensor for communication.

### To prepare the sensor for communication:

1. Go to the LINK SENSOR MENU screen.  
**Main > Sensor > Link to Sensor**
2. Select **New Sensor**. Press **ACT**.
3. Connect the transmitter to your sensor now if you have not already done so. If the screen times out, do **not** disconnect the sensor. Start from step 1 again.
4. After your sensor is connected, press **ACT**. The SENSOR READY 2 HRS screen appears.
5. The sensor will enter a two hour initialization period. Press any button to continue. After 2 hours your pump will alert you to enter a meter BG to calibrate your sensor.



## Calibrating the sensor

Two hours after you use your pump to start the sensor, your pump will alert you to enter a meter BG (METER BG NOW). This meter BG entry will be the **first** calibration for your sensor. You have to wait 10–15 minutes after calibration to see the first sensor glucose reading on the pump screen. Six hours after the first calibration, the pump will alert you to enter the second calibration.

After the second calibration, you must calibrate your sensor every 12 hours. If you do not enter a meter BG reading after 12 hours, your pump displays the METER BG NOW alert. Your pump will then stop calculating glucose values. However, about 20 minutes after you have entered a meter BG, your pump will continue calculating glucose values.

Follow these guidelines for best calibration results:

- Calibrate three to four times spread out throughout the day to improve accuracy.
- If you decide to insert a sensor before going to bed, you will need to set your alarm to make sure that you wake up and calibrate for your sensor to work correctly.
- You can calibrate anytime during any rate of change. Calibrating with two arrows however, is not optimal and may temporarily decrease accuracy until the next calibration.
- Enter your meter BG reading into the pump immediately after testing your BG. Do not wait to enter it later.
- Always use clean dry fingers when you check your blood glucose.
- Only use your fingertips to obtain blood samples for calibration.

After the transmitter successfully transmits signals to the pump, you may choose to put an occlusive dressing over the transmitter and the sensor.

## Entering meter BG for calibration

Sensor calibration is necessary for optimal glucose sensor performance. For sensor calibration, your pump accepts BG entries in the range of 40–400 mg/dL only.

Use any of the following methods for your sensor calibrations, including the first calibration after the initialization. You can enter BG values manually or through your linked meter.

### To enter BG values manually:

1. You can enter a meter BG value manually in the Bolus Wizard.
  - a. Press the **B** button on your pump, or use the MAIN MENU to go to the ENTER BG screen:  
**Main > Bolus > Use Bolus Wizard**
  - b. Use the up and down arrow buttons on your pump to enter your meter BG. Press **ACT**.
  - c. Select **Yes** to calibrate, or **No** to cancel, when the following screen displays: BG to update Sensor?
2. You can enter a meter BG value manually through the Sensor menu.
  - a. Follow this path:  
**Main > Sensor > Calibrate**
  - b. Enter the BG value, and then press ACT. Your sensor is now calibrated with the BG value you entered.
    - If the Bolus Wizard feature is off, the SENSOR MENU screen appears.
    - If the Bolus Wizard is on and the saved BG is below your BG Target range, the Cal Saved screen appears. This screen indicates that your saved BG is below your BG Target set in the Bolus Wizard feature, and the pump beeps three times. See *Setting the BG Targets, on page 88* for more information.
    - If the Bolus Wizard is on, the saved BG is above your BG Target range, and the calculated correction estimate is more than the preset scroll rate increment, the Cal Saved screen appears. This screen indicates that your saved BG is above your BG Target set in the Bolus Wizard feature, and the pump beeps three times. Go to the ENTER BG screen of the Bolus Wizard feature to enter a correction bolus. See *Using the Bolus Wizard feature* chapter for more information.

- If the information is not correct, select **Cancel**, then press **ACT**. The SENSOR MENU screen reappears with **Calibrate** selected. Repeat the procedure and enter the correct information.
3. You can enter a meter BG value manually through the Capture Event menu. Follow this path:

**Main > Capture Event > Enter BG**

See *Entering BG measurements* for more information.

**To enter BG values through your linked meter:**

1. Make sure that your pump and meter are programmed for communication. See the *Meter option* section for more information.
2. Test your BG with a fingerstick.
3. The BG value is automatically sent from the meter to your pump. This value displays in the following screen: BG to update Sensor. Select **Yes** if you want to calibrate your sensor. Select **No** if you do not want to use your BG value for calibration.



# 8



using your sensor



# 8 Using your sensor

## Status screens

Your STATUS screens tell you what is going on in your pump. In the SENSOR STATUS screen you can check the status of sensor information including when your next calibration will be needed, your sensor's age, and the state of your transmitter battery.

### To get to your status screens:

1. From the HOME screen, press the ESC button twice. This takes you to your pump status screen.
2. To see the Sensor Status screen, press ESC one more time. This screen will only be available if the Sensor feature has been turned On.

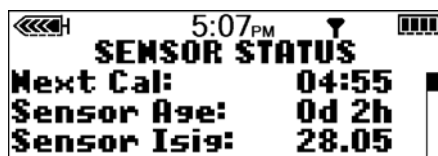
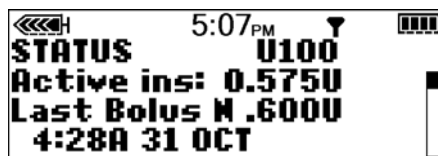

## Reading the sensor glucose graphs



**Note:** If your graphs say DEMO in the upper left corner of your screen, you must turn off the SENSOR DEMO mode to see your actual graphs (see the *Using the Sensor Demo* section in the *Sensor features* chapter).

After you insert the sensor and complete all steps found in *Setting up continuous glucose monitoring, on page 124*, your pump will display continuous glucose measurements. These measurements are generated by data sent from the sensor to the transmitter, and then to the pump every five minutes. The pump converts these measurements to glucose graphs that include the following information:

- **The most recent sensor glucose measurement or the reason that one is not displayed.**
- **The historical sensor glucose measurements or the reason that one is not displayed for the last 3, 6, 12 or 24 hours.**
- **Arrows that show the relative rate at which the most recent sensor glucose levels have risen or fallen.**

The following conditions can prevent a continuous sensor glucose measurement from being displayed:

- A sensor-related alert. See *Sensor alert conditions, on page 214* for information. Once you address the sensor-related alert, it may take up to 15 minutes for sensor glucose measurements to display.
  - **LOST SENSOR**
  - **SENSOR ERROR**
  - **CHANGE SENSOR**
  - **CAL ERROR**
  - **WEAK SIGNAL**
  - **METER BG NOW**
  - **SENSOR END**
- The transmitter is not linked to your pump. See the *Preparing the sensor for communication, on page 144* for more information.

In addition to sensor-related alerts, there are other conditions that prevent a continuous sensor glucose measurement from being displayed. The following messages will appear on your sensor glucose graph:



- **WARM-UP**

**Reason:** You started a new sensor or reconnected an old sensor, and the pump has entered a two-hour initialization period. Or, you entered a BG for calibration and your pump is waiting to receive the first valid sensor glucose value.

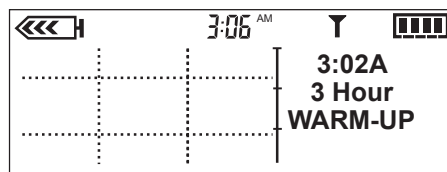

**Action:** The sensor is not ready to take glucose measurements. Your pump will notify you when the warm-up period ends and the sensor is ready to use. It may take up to 15 minutes after you calibrate your sensor for sensor glucose measurements to display.

- **METER BG**

**Reason:** It is time to calibrate your sensor.

**Action:** Take and enter a meter blood glucose measurement.

Follow the guidelines in the *Calibrating the sensor* section to calibrate your sensor.

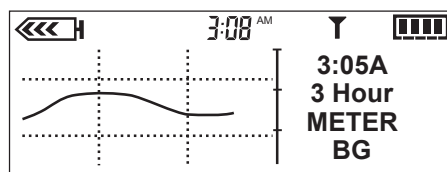

- **BELOW 40**

**Reason:** Your pump will not display sensor glucose readings below 40 mg/dL.

**Action:** Check your blood glucose with a fingerstick. Treat as prescribed by your healthcare professional.

**NOTE:** If your low sensor glucose alert is enabled, your pump will still trigger a low sensor glucose alert when your sensor glucose is below 40 mg/dL.

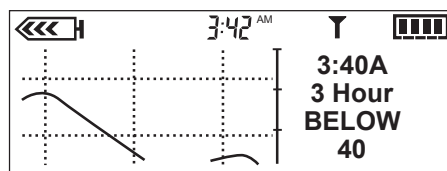

- **ABOVE 400**

**Reason:** Your pump will not display sensor glucose readings above 400 mg/dL.



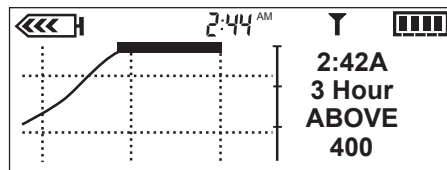

**Action:** Check your blood glucose with a fingerstick. Treat as prescribed by your healthcare professional.



*NOTE:* If your high sensor glucose alert is enabled, your pump will still trigger a high sensor glucose alert when your sensor glucose is above 400 mg/dL.

## Opening and viewing the graphs

The following table describes how to use the graphs.

<b>If you want to:</b>	<b>Do the following:</b>
Open the graphs	From the HOME screen, press <b>ESC</b> . The last graph you viewed (3-, 6-, 12- or 24-hour) shows the details for your most recent sensor glucose (SG) measurement.
View information in a graph	<p>If there is no SG measurement at the time you select, the reason for the missing measurement will be shown on the right side of the graph (for example, LOST SENSOR).</p> <ul style="list-style-type: none"><li>• When you open the graphs, the cursor (flashing vertical line) is always on the right edge of the graph and the graph shows the most recent SG measurement.</li><li>• Press  to move the cursor left to see an earlier SG measurement.</li><li>• Press  to move the cursor right to return to more recent SG measurements.</li></ul>
View different graphs	<ul style="list-style-type: none"><li>• With the cursor at the far right edge of a graph, you can press  to open the next graph.</li><li>• If the cursor is anywhere to the left of the far right edge, press <b>ESC</b> to move it to the right, then press  to open the next graph.</li></ul>

## The graphs

All graphs show High and Low Glucose Limits lines, a continuous SG measurement line, a data section, and the cursor (flashing vertical line).

When you open any graph, the cursor flashes on the right edge of the graph.

There are three marks on the cursor at 100, 200, and 300 mg/dL. The data section shows the most recent SG measurement or the reason why no measurement shows, and the time in the data section matches the time at the top of the screen.

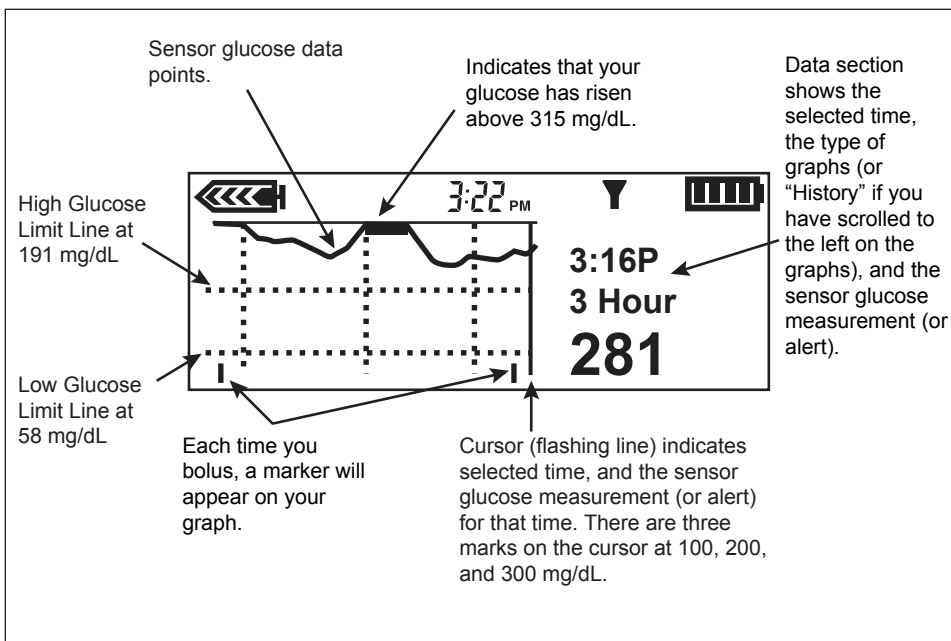

When you move the cursor left to select an earlier SG measurement, the data section of the graph turns black, the word History appears here, and the time in the data section changes to show the time when the SG measurement was taken or the reason why no SG measurement shows for that time.



**Note:** There are many reasons your graphs may not show an SG measurement, but your system does not alert for every one. Therefore, your system's alarm/alert history may not match the number of times your graphs do not show an SG measurement.

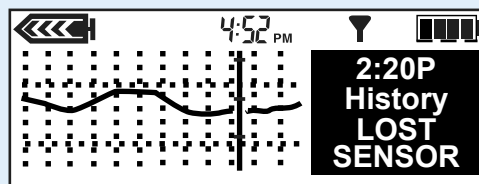

### Examples of continuous sensor glucose graphs

The following pages show examples of the different graph types.

### 3-hour graph

Each part of the graph between the vertical dashed lines represents one hour. In this example, the selected SG measurement was taken at 3:16 PM, and the value at that time was 281 mg/dL.

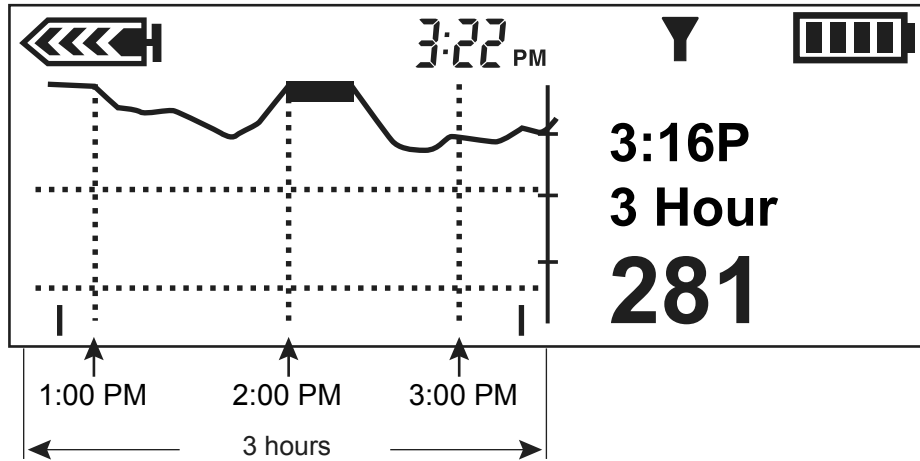

### 6-hour graph

Each part of the graph between the vertical dashed lines represents one hour. In this example, the selected SG measurement was taken at 1:12 AM, and the value at that time was 150 mg/dL.

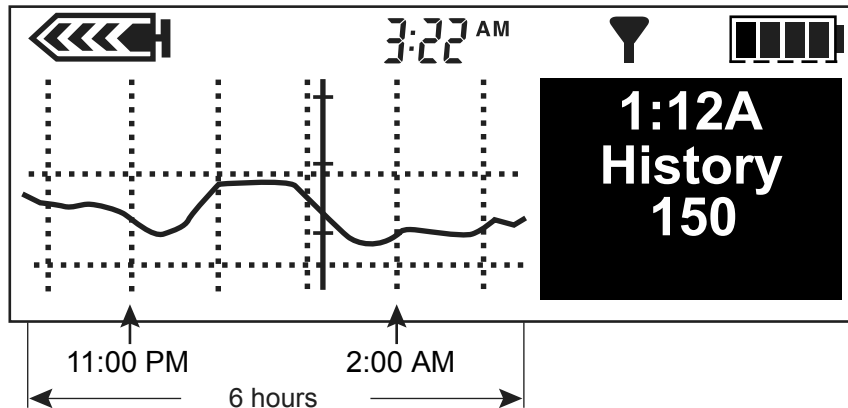

### 12-hour graph

Each part of the graph between the vertical dashed lines represents one hour. In this example, the reason no measurement is displayed is LOST SENSOR and it occurred at 2:20 PM.

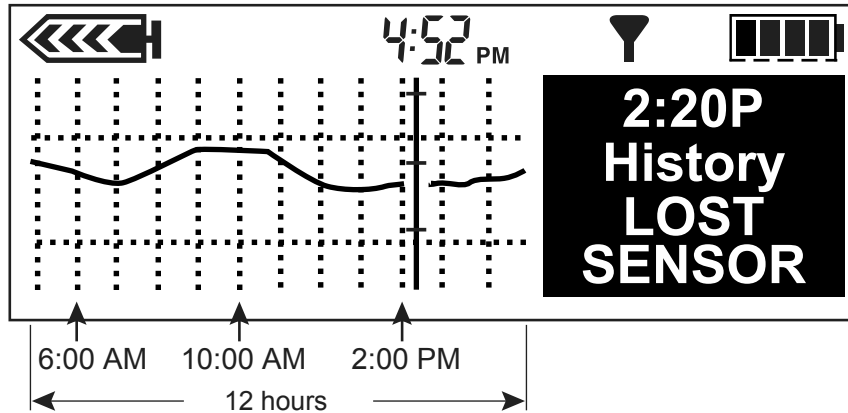

### 24-hour graph

Each part of the graph between the vertical dashed lines represents 12 hours. The shaded area helps you more easily see the sensor glucose measurements for the previous night. In this example, the selected SG measurement was taken at 11:50 AM and the value at that time was 211 mg/dL.

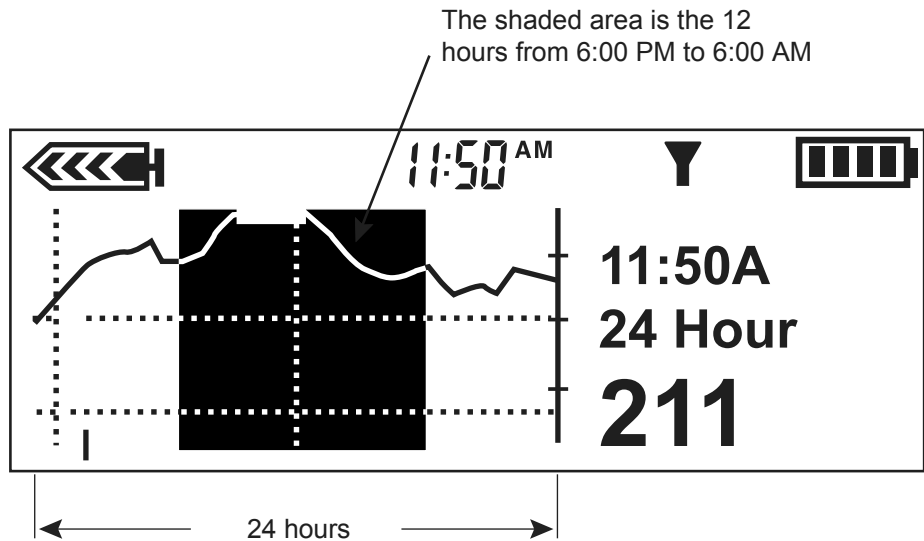

## How to check for rapid changes in sensor glucose

If your sensor glucose (SG) rises or falls faster than a certain rate, rapid change arrows automatically appear in the graphs next to the SG measurement, as shown in the following section.

### The rapid change arrows

These examples show how the rapid change arrows tell you when your SG rises or falls faster than a certain per-minute rate. The arrow direction shows if your SG measurements are rising or falling. The number of arrows (one or two) shows how rapidly your SG is changing.

- One up arrow ↑ shows that your SG has been rising at a rate of 1 to 2 mg/dL per minute.
- One down arrow ↓ shows that your SG has been falling at a rate of 1 to 2 mg/dL per minute.

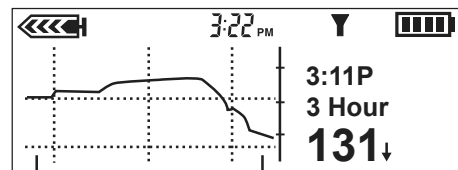
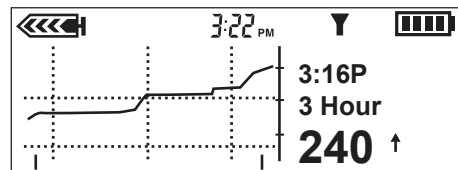

- Two up arrows ↑↑ show that your SG has been rising at a rate of 2.0 mg/dL or more per minute.

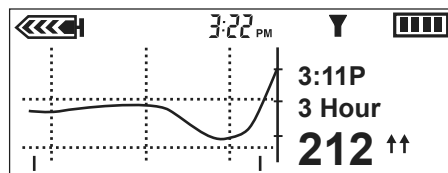

- Two down arrows ↓↓ show that your SG has been falling at a rate of 2.0 mg/dL or more per minute.

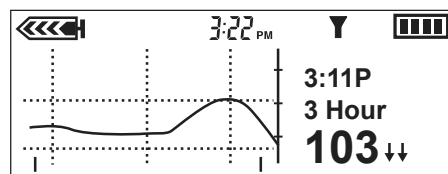

## How to make glucose alerts silent

The Alert Silence feature allows you to silence glucose alerts for a preset amount of time. You may use this feature when you are in a business meeting, watching a movie in a theater, and so on. The system records the time and glucose measurement for each alert during this silent period. You can see this alert information in the **SENSOR ALERT HISTORY** screen. See the *Sensor alert history* section in this chapter for details.

When one or more glucose alerts occur during the time when the Alert Silence feature is turned on, the pump displays the **ALERT SILENCE** screen without beeping or vibrating. If this alert is not cleared before the end of the silenced period, the pump beeps or vibrates periodically at the end of the preset time until the alert is cleared. Press **ESC**, then **ACT** to clear the alert.

You can make the glucose alerts silent in the following ways:

- Off** — This means the Alert Silence feature is **Off** and the alerts are **On**. The pump beeps or vibrates when any sensor glucose alert occurs.
- Hi Alerts** — The pump does not beep or vibrate if a high or rising sensor related alert occurs during the specified time.
- Lo Alerts** — The pump does not beep or vibrate if a low or falling sensor related alert occurs during the specified time.
- Hi and Lo Alerts** — The pump does not beep or vibrate if a high or low, rising or falling sensor related alert occurs during the specified time.

- **All Sensor Alerts** — The pump does not beep or vibrate if any sensor glucose alert occurs during the specified time, including the Hi and Lo glucose alerts, Cal Reminder, and Meter BG Now alerts.

The amount of time that you can make glucose alerts silent is:

- Minimum: 30 minutes
- Maximum: 24 hours

### **To make alerts silent:**

1. Open the SENSOR MENU.

**Main Menu > Sensor**

2. The SENSOR MENU shows you the current status of the Alert Silence feature.
3. Depending on your current settings, one of the following **Alert Silence** options will appear in the SENSOR MENU.
  - Alert Silence: Off
  - Alert Silence: Hi
  - Alert Silence: Lo
  - Alert Silence: Hi/Lo
  - Alert Silence: All
4. To change the current alert silence settings, select **Alert Silence**, then press **ACT**.
5. Select the alert silence option you want, then press **ACT**. The SET DURATION screen flashes a set of dashes or the length of time that you entered the last time you set an alert to silent.
6. Select your alert silence length between 30 minutes (minimum) and 24 hours (maximum), then press **ACT**. The pump is in Special mode for the set silenced period.

The SENSOR MENU shows the new alert that you selected to be silent.

7. Press the **ESC** button until the MAIN MENU appears.

## **Calibration history**

The CALIBRATE HISTORY screen lists the successful sensor calibration BG values that were entered into the pump more than 15 minutes ago.



**To view your Calibration History:**

1. Go to the CALIBRATE HISTORY screen.  
Main > Sensor > Calibration Hist.
2. The CALIBRATE HISTORY screen appears. It shows up to 28 calibration values.

**Sensor alert history**

The SENSOR ALERT HISTORY screen lists all of the sensor alerts that have occurred, displaying up to 36 alerts.

**To view your Sensor Alert History:**

1. Go to the SENSOR ALERT HISTORY screen.  
Main > Sensor > Sensor Alert History
2. The SENSOR ALERT HISTORY screen appears. The most recent alert is highlighted. Select the alert you want to get more information on, then press ACT.
3. A new screen will appear with the alert details.

**Using your system in water**

**WARNING:** Do not use your pump in water or wear it during water activities. The pump is not water-tight and it may become damaged if it is used in water.

**You should shower, bathe and swim with the transmitter and the sensor by following the guidelines below:**

1. Disconnect the infusion set from your site and remove the pump. The pump is not water-tight.
2. When the transmitter and sensor are connected, they form a water-tight seal to a depth of 8 feet (2.4 meters) for up to 30 minutes. You can shower and swim without removing them.
3. Once out of the water, put the pump back on and reconnect the infusion set.
4. Check your infusion set tape and the sensor tape to make sure that they are not damaged.



9



# 9 Utilities

## Alarm review

You can review alarms and their details in the ALARM HISTORY screen. This screen shows up to 36 past alarms, errors, or LOW RESERVOIR and LOW BATTERY alerts.

1. Go to the ALARM HISTORY screen.  
**Main > Utilities > Alarm > Alarm History**
2. Scroll through your past alarms.
3. In the ALARM HISTORY screen, select the alarm you want to review and press **ACT**. The details for that alarm will appear on the screen.
4. Press **ESC** to return to the ALARM HISTORY screen. Select another alarm to review, or exit the menus if you are done.

## Setting your alert type

You can select the type of alert your pump uses (for alarms, special conditions and programming). You can select a vibrate (silent) alert, or an audible beep alert. There are three beep types: long, medium and short tones. The factory setting for this feature is beep-medium.

The vibrate alert type is disabled if you use the block feature, and vibrate must be set again once block is turned off. Vibrate uses more battery power than the beep alert type and may shorten battery life. If your alert type is set to vibrate and you get a LOW BATTERY alert, your pump will use the beep alert type instead to conserve battery power.

1. Go to the ALERT TYPE screen.

## Main > Utilities > Alarm > Alert Type

2. Select your alert type and press **ACT**. That alert type is now active. Exit the menus.

## Auto-off

The factory setting for this feature is **Off**. This is a safety feature that stops insulin delivery after a defined time period (from 1 to 24 hours). If the pump detects that no buttons have been pressed for the selected amount of time in Auto-off, insulin delivery will stop and an alarm will sound. Your healthcare professional may have you program this feature based on the number of hours that you usually sleep at night. Consult your healthcare professional for the uses and settings that are best for you.

1. Go to the AUTO OFF DURATION screen.

### Main > Utilities > Alarm > Auto Off

2. Set the number of hours you want to set and press **ACT**.

If you do not want to use the Auto Off feature, make sure the hour is set to zero (0).

3. The screen will return to the ALARM MENU. The Auto Off feature is now set. Exit the menus.

## LOW RESV WARNING (Low reservoir warning)

The pump allows you to program an alert that will sound before your reservoir is empty. The warning works the same for both the 180-unit and the 300-unit reservoirs. You can select one of these warning types:

- a specified number of units that remain in the reservoir
- a specified maximum amount of time that remains before the reservoir will be empty

The factory setting for this feature is 20 insulin units.

If you use **Time** as the low reservoir warning type and you deliver large boluses, the actual time remaining could be less than the warning time. The warning time is based on the basal insulin delivery rate. The **Time** low reservoir warning type is intended to let you know if you will have enough insulin while you are sleeping.

1. Go to the RESV WARNING TYPE screen.  
Main > Utilities > Alarm > Low Resv Warning
2. Select **Insulin Units** or **Time** and press **ACT**.



**WARNING:** When the pump detects a low reservoir condition during a bolus or Fill Cannula delivery, the **LOW RESERVOIR** alert displays after the delivery is finished. Check the volume of your reservoir to make sure your pump does not run out of insulin, as this could lead to an under delivery of insulin.

a. **For Insulin units:**

In the WARNING UNITS screen enter the number of units you want remaining for the first warning, then press **ACT**.

The pump displays a LOW RESERVOIR alert first when the specified units remain, then again when half that remaining amount is used.

b. **For Time:**

In the WARNING TIME screen enter the amount of remaining time you want the first warning, then press **ACT**.

The pump displays a LOW RESERVOIR alert first when the specified time remains, then again up to one hour before empty or depending on programmed insulin delivery.

## Review daily insulin totals

The DAILY TOTALS screen provides a day-by-day history of the total amount of insulin for the last 32 days, including today. This screen includes all bolus and basal amounts delivered midnight-to-midnight for each of the last 32 days. The Today line in the DAILY TOTALS screen shows the amount of insulin you delivered so far that day.

The insulin used to fill the tubing or the cannula is not included in the DAILY TOTALS screen. This amount is counted separately and shown in the HISTORY screen of the RESERVOIR + SET MENU.

**Question:** Why should I review my daily totals?

**Answer:** Comparing your daily insulin deliveries to your blood glucose records helps you and your healthcare professional identify your optimal daily insulin rate(s).

**Question:** What is included in the daily totals?

**Answer:** Daily totals include all basal and bolus insulin deliveries, sensor glucose, meter blood glucose, and AUC information for that day.

## Pump data management

The pump data management feature allows you and your healthcare professional to view and manage your basal and bolus insulin delivery, food intake, BG data, SG data, and AUC data with averages. You can view the details of each day individually or you can average the data over a specified number of days (up to 32 days).

- **Daily totals** — The system automatically tracks certain types of information for you on a day-to-day basis. The daily totals are the totals for a single day.
- **Averages** — The system automatically calculates averages of certain types of information for you. There are two basic types of averages:
  - An average over a number of days (you select the number of days)
  - An average for a single day

The insulin delivery, food intake, sensor glucose information, meter blood glucose information, and AUC data includes daily totals and averages, as described in the following sections.

### Insulin delivery information

This table lists the different types of insulin delivery and food intake information that the system automatically records. This information is calculated by using all of the basal, bolus, and food data for that day.

An asterisk (\*) next to a date means that the data for that day will not be used for the calculations that are displayed in the Daily Average option. Anything, such as a time or date change, that shortens a day at least one hour and twelve minutes (01:12) will cause the asterisk to be displayed.



Item	Description
Carbs	The total number of <b>carbohydrates</b> entered using the Bolus Wizard and Capture Event (Meal marker) features.
Tot Insulin	The <b>total amount</b> of insulin delivered with the pump.
Basal (first line)	The <b>total amount</b> of insulin delivered as <b>basal</b> .
Basal (second line)	The <b>percent</b> of insulin delivered as <b>basal</b> .
Bolus (first line)	The <b>total amount</b> of insulin delivered as <b>bolus</b> .
Bolus (second line)	The <b>percent</b> of insulin delivered as <b>bolus</b> .
Food Only	The <b>total amount</b> of insulin delivered using the Bolus Wizard feature with <b>food amount only</b> .
#Food Only	The <b>number of times</b> the Bolus Wizard feature delivered a <b>food bolus only</b> .
Corr Only	The <b>total amount</b> of insulin delivered using the Bolus Wizard feature with <b>BG correction amount only</b> .
#Corr Only	The <b>number of times</b> the Bolus Wizard feature delivered a <b>BG correction bolus only</b> .
Food+Corr	The <b>total amount</b> of insulin delivered using the Bolus Wizard feature with <b>food and BG correction amount</b> .
#Food+Corr	The <b>number of times</b> the Bolus Wizard feature delivered a <b>food and BG correction bolus</b> .
Manual	The <b>total amount</b> of insulin delivered <b>manually</b> .
#Manual	The <b>number</b> of manual insulin deliveries.

### Sensor glucose information

This table lists the different types of sensor glucose information that the system automatically records. The sensor glucose information is calculated by using all of the sensor glucose measurements that were received by the pump during the day.

Item	Description
SG Average	The <b>average</b> sensor glucose measurement.

Item	Description
Above Hi Limit	The percentage of sensor glucose measurements that were <b>above</b> your High Glucose Limit.
Within Limits	The percentage of sensor glucose measurements that were <b>between</b> your Low Glucose Limit and your High Glucose Limit.
Below Low Limit	The percentage of sensor glucose measurements that were <b>below</b> your Low Glucose Limit.
SG Std. Dev.	The standard deviation of the sensor glucose measurements.
#Hi Alert	The number of High Glucose alerts.
#Lo Alert	The number of Low Glucose alerts.
#Predict Hi	The number of High Predictive Glucose alerts.
#Predict Lo	The number of Low Predictive Glucose alerts.
#Rise Rate	The number of Rise Rate alerts.
#Fall Rate	The number of Fall Rate alerts.
Number SGs	The number of SG measurements received from the transmitter.



### Meter blood glucose information

The table below lists the different types of meter blood glucose information that the system automatically records. The meter blood glucose information is calculated by using all of the automatic and manual meter blood glucose measurements that were received by the pump for the day, or number of days. This includes measurements that were manually entered into the pump during that time.

Item	Description
BG Average	The <b>average</b> meter blood glucose measurement.
Number BGs	The total number of meter blood glucose measurements taken.
Meter L/H	The <b>lowest</b> and <b>highest</b> blood glucose measurements sent by the meter (L is the lowest, and H is the highest). These can be used for calibration or non-calibration purposes.

Item	Description
Manual L/H	The <b>lowest</b> and <b>highest</b> manually entered blood glucose measurements (L is the lowest, and H is the highest). These can be used for calibration or non-calibration purposes.

### To view data for a single day:

- Go to the DAILY TOTALS screen.  
**Main > Utilities > Daily Totals**
- Select the day that you want to view.
  - To view totals for today, select **Today**.
  - To view totals for a previous day, select the date.
- Press **ACT**. The DELIVERY STATS screen shows the basal, bolus, and food intake information for the day you selected in step 2. This day is shown on the title line of the screen.
- Press  to view more information. See the table in the *Insulin delivery information* section in this chapter for descriptions of information shown here.
- To view sensor glucose information for the same day you have selected in step 2, press **ACT** from the DELIVERY STATS screen. The SENSOR STATS screen appears, showing the sensor glucose information for the day you selected. The day you selected is shown on the title line of the screen.
- Press  to view more information. See the table in the *Sensor glucose information* section in this chapter for descriptions of the sensor glucose information.
- To view meter blood glucose measurement information for the same day you have selected in step 2, press **ACT** from the SENSOR STATS screen. The METER STATS screen appears, showing the meter blood glucose information for the day you selected. The day you selected is shown on the title line of the screen.
- Press  to view all of the information in the METER STATS screen. See the table in this section for descriptions of the meter blood glucose information shown here.

9. Press **ACT** to toggle between the different STATS screens. Press **ESC** from any STATS screen to go to the DAILY TOTALS screen.

Continue viewing daily totals by following the steps above, or press **ESC** until the HOME screen appears.



The following procedure shows you how to view insulin delivery, food intake, sensor glucose and meter blood glucose data for a selected number of days.

**To view data over a number of days:**

1. Go to the DAILY TOTALS screen.

**Main > Utilities > Daily Totals**

The DAILY TOTALS screen shows **Daily Average** selected.

2. Press **ACT**. The DAYS TO AVERAGE screen flashes the number of days you selected the last time you used this feature.
3. Select the number of days that you want to average. For example, if you want to see the averages for the last seven days, select 7.
4. Press **ACT**. A message tells you that the pump is calculating the averages. The DELIVERY STATS screen shows the insulin delivery and food intake information for the number of days you selected. The number of days is shown on the title line of the screen.
5. Press  to view more information. See the table in the *Insulin delivery information* section in this chapter for descriptions of the information shown here.
6. To view sensor glucose information for the same days you selected in step 3, press **ACT**. The SENSOR STATS screen appears, showing the sensor glucose information.
7. Press  to view more information. See the table in the *Sensor glucose information* section in this chapter for descriptions of the information shown here.
8. To view meter blood glucose measurement information for the same days you selected in step 3, press **ACT**. The METER STATS screen shows the meter blood glucose information.

- Press  to view more information. See the table in the *Meter blood glucose information* section in this chapter for descriptions of the information shown here.

### AUC calculation

The AUC (Area Under the Curve) feature measures how much and how long your sensor glucose measurements are outside the user-defined AUC Limits. Consult your healthcare professional for the AUC settings that are best for you. The AUC Limits are different than the Glucose Limits. The AUC Limits are used to analyze the sensor glucose measurement data that is stored in your system. The closer the AUC values are to zero, the closer your SG values are to your AUC Limits. If your AUC values are zero, then your SG values are within your AUC Limits.

In the following example the AUC Limits are defined as 70 to 140 mg/dL, and are represented by the light shaded area. The actual AUC is the dark shaded area, between the sensor glucose curves and the defined limits. On average, the SG exceeded the AUC high limit by 30 mg/dL, and the AUC low limit by 3.9 mg/dL.

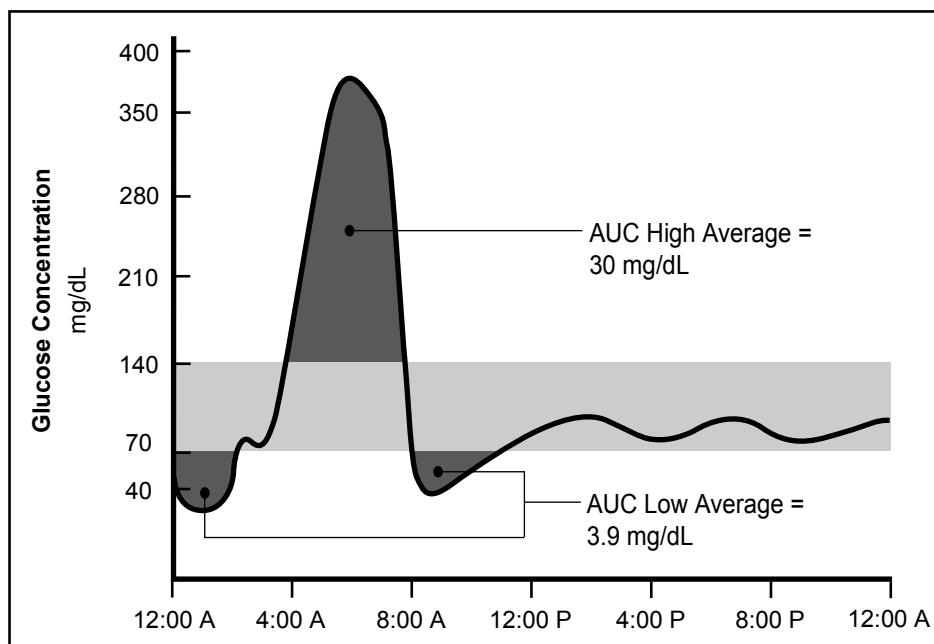

The default AUC Limits are:

- Low AUC Limit: 70 mg/dL
- High AUC Limit: 180 mg/dL

### **To set the AUC Limits:**

1. Go to the AUC MENU.  
**Main > Utilities > Daily Totals > Calculate AUC**
2. Select **AUC Limit**, then press **ACT**. The SET AUC LIMITS screen appears. The default LOW AUC Limit flashes 70 mg/dL.
3. Select your Low AUC Limit. The number must be between 40 and 400 mg/dL.
4. Press **ACT**. The default High AUC Limit flashes 180 mg/dL.
5. Select your High AUC Limit. The number must be between 40 and 400 mg/dL. It can be equal to, but not lower than, the AUC Low Limit.
6. Press **ACT**. The AUC MENU screen shows the AUC Limit you selected.

### **To view AUC data for a single day:**

1. Go to the AUC MENU.  
**Main > Utilities > Daily Totals > Calculate AUC**
2. Select the day that you want to view.
  - To view totals for today, select **Today**.
  - To view totals for a previous day, select the date.
3. Press **ACT**. AUC High and AUC Low values appear for the selected day.
  - **AUC High** is the average of AUC for sensor glucose values above the AUC High Limit for that day.
  - **AUC Low** is the average of AUC for sensor glucose values below the AUC Low Limit for that day.

### **To view AUC data over a number of days:**

1. Go to the AUC MENU.  
**Main > Utilities > Daily Totals > Calculate AUC**
2. Select **AUC #Days**, then press **ACT**.

3. The DAYS TO AVERAGE flashes the number of days to average. Select the number of days you want. For example, if you want to see the averages for the last seven days, select 7.
4. Press **ACT**. A message tells you that the pump is calculating averages.
5. The Day Average screen shows the data for the number of days you selected. The number of days is shown on the screen. For example, if you have selected seven days, the screen title will be 7Day Average. AUC High and AUC Low appear below the title.
  - **AUC High** is the average value of AUC for sensor glucose values above the AUC High Limit for the number of days selected.
  - **AUC Low** is the average value of AUC for sensor glucose values below the AUC Low Limit for the number of days selected.

## Personal reminders

### Alarm clock

The alarm clock is a feature that allows you to set a maximum of eight daily reminders for various events. The factory setting for this feature is off. The alarm clock can be useful to remind you when to check your blood glucose, eat, bolus, etc. However, do not rely on the alarm clock feature as the only reminder for monitoring your diabetes. When the alarm clock goes off, the ALARM CLOCK screen appears. Press **ESC**, then **ACT** to clear the reminder.

1. Go to the ALARM OPTION screen.  
**Main > Utilities > Alarm Clock**
2. Select **On/Set**. Press **ACT**.
3. Select **Add Alarm**. Press **ACT**.
4. Enter the hour (flashing). Press **ACT**.
5. Enter the minutes (flashing). Press **ACT**.
6. Repeat steps 3 through 5 to program additional alarm times. Exit the menus when you are done.

## PC connect for change settings

PC Connect for Change Settings option allows you to connect your pump to your computer, permitting a change of settings, by way of RF (radio frequency). At this time, PC software to modify pump programmed settings is not available and therefore the Change Settings option is not functional. If you should accidentally navigate to the **Change Settings** option as shown below, press **ESC** to cancel.

Main > Utilities > Connect Devices > PC Connect

## Remote control option

The factory setting for this feature is off. Consult with your healthcare professional before using the Remote Control feature. You should be familiar with the basic functions of your pump before you use this option. Remote controls can be purchased from Medtronic Diabetes.

Refer to the remote control user guide for operating instructions.



**Note:** The use of RF (radio frequency) devices with the pump reduces battery life.

To use the remote control, these pump settings must be programmed:

- Remote Options = On
- Remote control ID code entered in pump (code is on back of remote)
- Easy Bolus = On

## Turn on remote control option



**WARNING:** Do not use your remote control when your pump has a **LOW BATTERY** condition because your pump will not receive signals from the remote.

1. Go to the REMOTE OPTION screen.

Main > Utilities > Connect Devices > Remotes

2. Select **On**, then press **ACT**.



3. The REMOTE ID MENU screen appears. Add, delete or review your remote ID as described in the next section. Exit the menus if you are done.

### Add, delete, review remote control IDs

Each remote control has its own unique ID. Up to three different remote control IDs can be programmed in your pump. You must turn on the remote option to add, delete or review the remote control IDs programmed in your pump.

1. **Adding a remote ID**
  - a. Select **Add ID** from the REMOTE ID MENU screen, then press **ACT**.
  - b. Enter each of the six ID numbers found on the back of the remote control. Press **ACT** after each entry. After you set the last number of the ID, the screen will return to the REMOTE ID MENU.
2. **Deleting a remote ID**
  - a. Select **Delete ID** from the REMOTE ID MENU screen, then press **ACT**.
  - b. Select the remote ID that you want to delete, then press **ACT**. The selected ID is now deleted.
3. **Reviewing remote IDs**
  - a. Select **Review ID** from the REMOTE ID MENU screen, then press **ACT**.
  - b. The programmed IDs will show in the REVIEW REMOTE ID screen.
4. Exit the menus when you are done.

### Other Devices option



**WARNING:** Do not use accessories that have not been approved for use with the MiniMed 530G System. Use of unapproved devices can have software incompatibility and can result in inaccurate data transfer that may result in harm. Bayer's CONTOUR® NEXT LINK Wireless Meter and the remote control are the only devices that have been approved for use with this system.

## Block feature

Block restricts access to pump programming. The factory setting for this feature is off. Block is an important safety feature if the pump user requires someone else to maintain complete control of pump operation. When block is on, the remote control is used to deliver a bolus and manually suspend/resume the pump. (You can order the remote control from Medtronic Diabetes.)

Direct pump programming is limited to manual Suspend, Threshold Suspend, Block, and Selftest. You can still view status-type screens such as STATUS, BOLUS HISTORY, BASAL REVIEW, and DAILY TOTALS. Consult your healthcare professional before using Block mode.

## Turning block on



**Note:** The vibrate alert-type is disabled when block is on.

1. Go to the BLOCK OPTION screen.  
**Main > Utilities > Block**
2. Select **On**, then press **ACT**. The HOME screen will appear with an open circle. The Block option is now on and the pump is in Special mode. Exit the menus.



## Example: Block

Oscar is an elderly man with diabetes who needs assistance with all of his daily living activities. He needs his caregiver or family member to help him with his pump as well. To be sure that Oscar does not change any pump settings, his family programmed his pump with the Block feature turned on. They use the Remote Control to give him his boluses when he needs them.



**Caution:** This elderly patient can still manually suspend the pump which may result in high blood glucose and ketoacidosis.

## Lock keypad feature

Lock keypad prevents accidental pump keypad presses. You can only press the  to view the STATUS screen, and the  button to turn on the backlight. The remote control can be used to give a bolus or put the pump into manual Suspend.



A locked keypad is automatically unlocked during the following:

- Battery insertion
- Alarms
- Alerts

### Locking the keypad

1. Go to the UTILITIES MENU.
2. Select **Lock Keypad**, then press **ACT**.
3. Press **ACT** again to lock the keypad. The KEYPAD LOCKED screen appears with instructions on how to unlock the keypad.

### Unlocking the keypad

Press the  button and the  button at the same time. Keypad Unlocked screen appears.

## Selftest

Selftest is a safety utility that allows you to check if your pump is operating properly. This self-diagnostic feature can be used for maintenance or to check your pump if it operates unusually. During selftest, your pump will automatically run internal tests, including a check for proper operation of the beep and vibrate modes. The selftest is additional to the routine tests that run independently while the pump operates.

Contact our 24 Hour HelpLine if any of the tests do not occur as described here.



**Note:** If the pump detects a condition such as low battery, the selftest will not finish. A message will appear to show the condition that caused the test to stop.

1. Go to the UTILITIES MENU.  
**Main > Utilities > Selftest**
2. Select **Selftest**, then press **ACT**.
3. Periodically, you will hear beeps as different mechanisms in the pump are being tested. As part of the selftest, the pump will do these tests:
  - a. Screen Test:  
The screen will appear all black.
  - b. Selftest:  
The pump will count down from 10.
  - c. Tone Test:  
You should hear beeps.
  - d. Vibrate Test:  
You will feel vibrations.
4. After the selftest is finished, TEST COMPLETE screen appears. The screen will return to the UTILITIES MENU, then to the HOME screen.

## User settings

The user settings function allows you to save, restore, and clear all pump settings. You can also view a listing of the dates and times of all recent user settings operations you have done. The Save Settings feature lets you keep a set of pump settings that you can restore to your pump if it is cleared or you need to go back to these settings for any reason.

When you clear your pump, the pump settings are restored to the factory defaults, and you must either use Restore Settings, if you have saved a set of pump settings, or reprogram all your settings before you can use your pump again. The pump does not clear the internal pump memory.

## Saving the settings

### Do these steps to save your current pump settings:

1. Go to the UTILITIES MENU screen and select **User Settings**.

### Main > Utilities > User Settings

2. Hold down **↶B** and press **ACT**.
3. The USER SETTINGS screen is displayed with **Save Settings** highlighted. Press **ACT**.
4. If this is the first time you have saved pump settings, go to step 5. If you have previously saved pump settings, a message displays, indicating the date of your last pump settings save. Read the instructions on the screen, then press **ACT** to save your current settings. You can press **ESC** if you want to cancel the save.
5. The SETTINGS SAVED message displays to confirm that your current pump settings have been saved. Exit the menus.

### Restoring the settings

**Do these steps to restore the most recent pump settings you have saved to your pump:**

1. Go to the UTILITIES MENU screen and select **User Settings**.

### Main > Utilities > User Settings

2. Hold down **↶B** and press **ACT**.
3. The USER SETTINGS screen is displayed. Select **Restore Settings**, then press **ACT**.
4. A message displays, giving you the option of restoring the pump settings that were saved on the given date and erasing the ones currently on your pump. Read the instructions on the screen then press **ACT** to restore the settings. You can press **ESC** if you want to cancel the restore.
5. The SETTINGS RESTORED message displays to confirm that your current pump settings have been replaced with the pump settings you had saved on the given date. Exit the menus and check your pump settings to verify the restore.

### Clearing the settings

Take the following steps only if you want to clear your pump to factory default settings.



**Caution:** Do not clear your pump settings unless directed by your healthcare professional. If you clear your pump settings, it will be necessary to reprogram all your personal pump settings as directed by your healthcare professional.

1. Make sure the pump is not connected to your body.
2. Go to the UTILITIES MENU screen and select **User Settings**.  
**Main > Utilities > User Settings**
3. Hold down **↶B** and press **ACT**.
4. The USER SETTINGS screen is displayed. Select **Clear Settings**, then press **ACT**.
5. A CONFIRM message displays, giving you the option of clearing your pump settings or not. Select **YES** and press **ACT** to clear the settings. You can press **ESC** if you want to cancel.
6. You will see a RESET alarm, and then the pump will go through various screens while it restarts. After the pump clears all of your settings, the screen will go to the TIME/DATE SETUP screen.
7. Reset the time and date as described in *Setting the time and date* section in the *Basic programming* chapter.
8. After you set the time and date, you must rewind your pump. Refer to the *Rewinding your pump* section in the *Starting on insulin* chapter for instructions. Remember, all your settings have been cleared and you must either restore or reprogram all your settings.

## History

**If you want to view a listing of the dates and times of all recent User Settings operations you have done on your pump, such as saves and restores, take the following steps:**

1. Go to the UTILITIES MENU screen and select **User Settings**.  
**Main > Utilities > User Settings**
2. Hold down **↶B** and press **ACT**.
3. The USER SETTINGS screen is displayed. Select **History**, then press **ACT**.

4. The SETTINGS HISTORY screen displays, giving you a list of all the dates and times of your most recent User Setting operations. Scroll down to view the entire history. When you are done looking at the history, press **ESC** to exit the menu.





10

meter option



# 10

## Meter option

### About meters

You can set up your pump to automatically receive your blood glucose readings from Bayer's CONTOUR® NEXT LINK Wireless Meter. Refer to the instructions

*page 147* to enter BG values through your linked meter for calibration.

Your pump is set at the factory with the meter option turned off. See the *Add, delete, review meter IDs* section in this chapter to turn the meter option on, and to enter your meter ID. Programming your meter ID links your pump to the meter. Each meter has its own unique ID. You can link up to three meters to your pump. If you do not link the meter to your pump, you must enter your blood glucose readings manually.

When the pump is idle (at the HOME screen), it will beep or vibrate when it receives a blood glucose reading from the meter. The reading will appear on the pump screen. If your BG reading is not within your set BG Target range, the pump beeps three times. For BG readings that are above the set BG Target range, use the Bolus Wizard feature to enter a correction bolus.



**Note:** The use of RF (radio frequency) devices with the pump reduces pump battery life.



You have to turn on the meter option to add, delete or review the meter ID(s) programmed in your pump. The meter ID is printed on the back of the meter. See the user guide that came with your meter for detailed information on how to use it.

## Meter rules

**If you want your pump to communicate with the meter, the following conditions must apply:**

1. The meter option must be turned on and programmed. Refer to the instructions in this section.
2. Your pump must be within 4 feet (1.2 meters) of your meter to receive the blood glucose reading.
3. The pump cannot have a LOW BATTERY alert condition.
4. When programming a bolus, the blood glucose measurement from the meter will appear as the default blood glucose value on the ENTER BG screen. The pump will not display a reading that is older than 12 minutes on the ENTER BG screen.



**Caution:** Do not use your linked meter to send BG readings to your pump when your pump has a LOW BATTERY condition. Your pump will not receive BG readings from the meter when the battery life is low.

## Add, delete, review meter IDs

The meter programming screens are very similar to those for the remote control. Make sure to select **Meters** in the DEVICE OPTIONS screen when programming your meter.

You have to turn on the meter option to add, delete, or review the meter ID(s) programmed in your pump.

**To turn on the meter option:**

1. Go to the METER OPTION screen.

**Main > Utilities > Connect Devices > Meters**

2. Select **On**, then press **ACT**. The METER ID MENU appears.
3. Add, delete or review your meter ID(s) as desired.

#### Adding meter IDs

- a. Select **Add ID**, then press **ACT**.
- b. Use the up and down arrow buttons to enter each of the six ID characters. Press **ACT** after each entry.
- c. After you set the last character of the ID, the screen will return to the METER ID MENU.

#### Deleting meter IDs

- a. Select **Delete ID**, then press **ACT**.
- b. Select the meter ID that you want to delete and press **ACT**.
- c. The selected ID is now deleted.

#### Reviewing meter IDs

If you are not sure that your meter ID is entered in your pump, check the REVIEW METER ID screen.

- a. Select **Review ID**, then press **ACT**.
  - b. The programmed IDs will show in the REVIEW METER ID screen.
4. Exit the menus when you are done.



# 11



therapy management software





# 11 Therapy management software

Medtronic provides software to optimize your pump use. Contact our 24 Hour Helpline for more information.

## CareLink® Personal

Your pump provides continuous glucose values so that you can track glucose concentration patterns and possibly identify episodes of low and high blood glucose. It also stores glucose data so that it can be analyzed to track patterns or uploaded to CareLink Personal for analysis of historical glucose values.

CareLink Personal software is a Web-based system designed to help you manage your diabetes. It has many key features:

- It copies (uploads) data from your devices: insulin pump and supported blood glucose meters.
- Device data is stored on a centralized database.
- There is an online logbook where you can record self-reported information, such as how many carbohydrates you consumed.
- Uploaded data and other information stored on the system can be viewed through several different types of reports.
- Access to data and personal information on this system is secure.

## Reports

Reports show you data gathered from your device uploads, and from what you directly entered into the system. Examples of the report data you can get include:

- Pump operation, such as alarm settings and maximum allowed bolus amount.

- Insulin delivery rates, types and times.
- Blood glucose reading levels and times.
- Sensor glucose reading levels and times.
- Bolus Wizard or online logbook entry data.

Reports are displayed in PDF format. They can be viewed online, saved, or printed.

You can share your reports with your healthcare professional. These reports can help you and your healthcare professional to discover trends and other information. This can lead to improved therapy management for greater control.

## Logbook

The logbook allows you to enter the following self-reported information:

- Carbohydrates consumed
- Exercise activity
- Urine ketone results
- HbA1c results
- Infusion set changes

The data from your logbook is used in the reports you create. You can see how, for example, your carbohydrate intake compares to blood glucose levels for the same day or time. You can also use it as an online diary of your diabetes management.

# 12

insulin pump therapy follow-up



# 12 Insulin pump therapy follow-up

We hope that you are now comfortable using the pump and your blood glucose values have improved through insulin pump therapy. Diabetes management requires much more than blood glucose control. You need to take care of your complete physical and mental health. This includes seeking treatment for any condition both directly related to and not related to diabetes. The following recommendations apply to general diabetes as well as insulin pump therapy follow-up. Always consult your healthcare professional with any questions about your diabetes management.

## Recommended follow-up

### Everyday

- Check blood glucose four to six times a day and always before bed.
- Test before driving and have a fast-acting carbohydrate with you when you drive.
- If your blood glucose is above 250 mg/dL twice in a row, take an injection and change the infusion set.

### Every month

- Review DKA prevention guidelines.
- Check 3:00 AM blood glucose at least once during the month.
- Check two-hour post-meal blood glucose for all meals on a given day.

### **Every three months**

- Visit your healthcare professional, even if you feel well and your blood glucose values are within target range.
- Review your blood glucose log and insulin pump settings with your healthcare professional.
- Make sure you have an HbA1c test done.

### **Laboratory tests**

- Test for HbA1c every three months
- Test for cholesterol, HDL, LDL, triglyceride yearly
- Test for microalbuminuria yearly

### **Every visit**

- Blood pressure check
- Foot exam
- Review goals for blood glucose, meal plan and exercise

### **Annually**

- Dilated eye exam by a qualified eye care professional
- Annual flu shot
- Regular dental visits
- Nerve function tests
- EKG test over age 35
- Prostate exam for men, breast exam for women
- Diabetes education review
- Replace Glucagon Emergency Kit (new prescription from your healthcare professional)

# 13

■ alarms and alerts





# 13

## Alarms and alerts

This chapter is designed to help you understand the messages that your pump is giving you when you get an alarm or an alert message. For help on common conditions that might occur with your pump, see the *Troubleshooting* chapter.

### About alarms and alerts

Your pump has a sophisticated network of safety checks and systems. If the safety network detects anything unusual, your pump notifies you of conditions that require your immediate attention. The backlight illuminates the pump screen and the alarm or alert message displays on the screen.

It is important that you understand how your pump behaves when you do not clear an alarm or an alert:

- Alarm — If you do not clear an alarm, insulin delivery remains suspended, and the pump does not display any subsequent alarms or alerts until the first alarm is cleared. After you clear the first alarm, the pump displays any subsequent alarms, followed by any alerts in order of their importance.
- Alert — If you do not clear an alert, the pump does not display any subsequent alerts until the first alert is cleared. However, the pump displays an alarm even if you do not clear the alert. After you clear the first alert or alarm, the pump displays any subsequent alarms or alerts in order of their importance.

Check your pump and test your blood sugar. Follow the guidelines prescribed by your healthcare professional to manage your diabetes as needed.



**Note:** The STATUS screen shows any alarms and alerts that are active.

### Example:

John's pump displays a BUTTON ERROR alarm, but he does not clear it. During the time that his pump displays the BUTTON ERROR alarm, his pump receives a LOW RESERVOIR alert. A few minutes later, his pump receives a NO DELIVERY alarm. John's pump does not display the LOW RESERVOIR alert or the NO DELIVERY alarm until he clears the first alarm. After John clears the BUTTON ERROR alarm, his pump displays the NO DELIVERY alarm. After he clears the NO DELIVERY alarm, his pump displays the LOW RESERVOIR alert.



## Alarms

An alarm warns you that the pump detected something that prevents insulin from being delivered. An alarm means that insulin delivery stopped, the pump has been placed in Attention mode, and a solid circle displays on the pump screen. It is important that you respond to an alarm.



**WARNING: Do not ignore your pump when it is in Attention  mode because all insulin delivery is stopped, which may lead to high blood glucose and ketoacidosis.**

**Question:** Why are alarms important?

**Answer:** Your pump monitors activities and notifies you if there is an unusual pump status or your attention is required. When an alarm is active, INSULIN DELIVERY IS STOPPED and immediate operator interaction is required.

If the vibrate mode is on and your pump triggers the THRESHOLD SUSPEND alarm, it immediately starts with a siren to get your attention. (For all other alarms and alerts, the pump first vibrates and then changes to beeps if alarm or alert is unattended.)

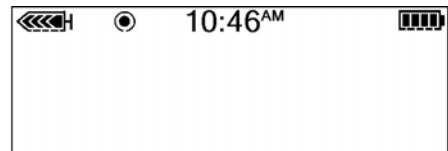

When a solid circle appears, follow the instructions on the screen

For your safety, if there is no response after 10 minutes, any beeps that have started will change to a siren. The siren continues every minute until the alarm is cleared.

## What to do

When an alarm is triggered, the pump goes into Attention mode and an alarm message shows on the screen. The pump then defaults to the HOME screen. Do these steps when you get an alarm:

1. **View the alarm.** From the HOME screen, press any button to see the alarm message.
2. **Read all of the alarm text.** There are instructions on how to fix the alarm condition. (Press  to read more text, if available.)
3. **Clear the alarm.** Press **ESC** then **ACT** after you read the alarm instructions. The HOME screen appears.
4. **Follow the instructions** that appeared with the alarm to fix the alarm condition.
5. **Check your settings.** Check your time, date, basal and other settings to make sure they are correct.

## Alarm conditions

Listed below are alarms relating to your pump, along with the reasons they appear, and suggested steps for resolution.



### A (ALARM)

**Reason:** The pump performed a series of system and safety checks. It has detected an unusual event. This alarm shows the letter A followed by two numbers. Insulin delivery has stopped. Your pump settings are retained.

**Action:** Clear the alarm by pressing **ESC**, then **ACT**. If this alarm repeats often, note the alarm number then call our 24 Hour HelpLine for assistance.



## AUTO OFF

**Reason:** No buttons were pressed during the time limit you set for the AUTO OFF DURATION feature. Insulin delivery has stopped.

**Action:** Clear the alarm by pressing **ESC** and **ACT**. Consult your healthcare professional for the settings that are best for you. To adjust this setting, see *Auto-off, on page 166*.



## BATT OUT LIMIT

**Reason:** The battery has been out of the pump for more than five minutes. Insulin delivery has stopped.

**Action:**

1. Clear the alarm by pressing **ESC** and **ACT**.
2. Verify that the pump time and date are correct. If not correct, go to the UTILITIES MENU and reset the date and time.



## BUTTON ERROR

**Reason:** A button has been continually pressed for more than three minutes. Insulin delivery has stopped.

**Action:** If this alarm occurs again, call 24 Hour Helpline. Clear the alarm by pressing **ESC** and **ACT**. If you are unable to clear the alarm:

1. Your pump is not delivering insulin. Check your BG and treat as necessary, following the instructions from your healthcare professional.
2. Call the 24 Hour Helpline for assistance with your pump.



## BOLUS STOPPED

**Reason:** The battery cap is loose or the pump was bumped or dropped during a bolus. This alarm can also occur if the pump receives a static shock. As a safety measure, the pump stops the bolus when this happens. Bolus and basal insulin delivery has stopped.

**Action:**

1. Clear the alarm by pressing **ESC** and **ACT**.
2. Visually inspect your pump to make sure that it is not damaged in any way.
3. Check the BOLUS HISTORY screen to review how much of the bolus was actually delivered. If necessary, reprogram a bolus with the amount not yet delivered.



## CHECK SETTINGS

**Reason:** This alarm is telling you to make sure that all your settings are correct. Insulin delivery has stopped. This alarm occurs after any of these actions:

- All user settings were cleared (set back to their defaults) because there was an E-error alarm.
- The Clear Settings function was performed.
- After you rewind when practicing without a reservoir when you first get your pump. In this case, it is just a reminder to make sure all your settings are programmed before you begin using the pump with insulin.

**Action:** Clear the alarm by pressing **ESC** and **ACT**. The pump settings are restored to the factory defaults, including the time and date. You must either use Restore Settings, if you have saved a set of pump settings, or reprogram all your settings before you can use your pump again.



## E (ERROR)

**Reason:** The pump performed a series of system and safety checks. It has detected an unusual event. An E-error alarm will show the letter *E* followed by two numbers. E-alarms cause all insulin delivery to stop, the pump resets, and all your settings are cleared.

**Action:** Note the error number then call our 24 Hour HelpLine for assistance.



## EMPTY RESERVOIR

**Reason:** There is no insulin in the reservoir. Insulin delivery has stopped.

**Action:** Clear the alarm by pressing **ESC** and **ACT**. Change the reservoir immediately.



### FAILED BATT TEST

**Reason:** The battery inserted does not have enough voltage. Insulin delivery has stopped.

**Action:** Clear the alarm by pressing **ESC** and **ACT**. Insert a new battery immediately.



### FINISH LOADING

**Reason:** You have not completed filling the infusion set with insulin. Your pump is not delivering insulin.

**Action:** Clear the alarm by pressing **ESC**, then **ACT**. This resumes basal delivery. See the *Filling the cannula* section in the *Starting on insulin* chapter to fill the infusion set cannula with insulin. If you are using an infusion set with a needle, press **ESC** to skip this step.



### MAX FILL REACHED

**Reason:** You used more than 30 units of insulin to fill the infusion set tubing. Your pump is not delivering insulin.

**Action:** Clear the alarm by pressing **ESC**, then **ACT**. See the *Filling the tubing* section in the *Starting on insulin* chapter for more information.



### MAX DELIVERY

**Reason:** You have taken more insulin than expected based on Maximum bolus and Maximum basal rates. Insulin delivery has stopped.

**Action:** Check your BG and treat as necessary, following the instructions from your healthcare professional. Clear the alarm by pressing **ESC**, then **ACT**.



### MOTOR ERROR

**Reason:** Your pump detected a motor error. Insulin delivery has stopped.

**Action:**

1. Clear the alarm by pressing **ESC**, then **ACT**.

2. Follow the instructions on the screen.
3. If the error occurs again, call our 24 Hour HelpLine for assistance.



### NO DELIVERY

**Reason:** Your pump detects a blockage or the reservoir is empty. Insulin delivery has stopped.



**Note:** A NO DELIVERY alarm may prevent the EMPTY RESERVOIR alarm from displaying.

#### Action:

1. Check if your infusion set is dislodged or kinked.
2. Check your blood glucose and follow your prescribed safety guidelines for treating high glucose if necessary.
3. Clear the alarm by pressing **ESC**, then **ACT**. A screen appears with two choices: **Resume** and **Rewind**.
4. Make sure that there is insulin in your reservoir.
  - a. If you identified and fixed a kink in your tubing, select **Resume**.
  - b. If the reservoir is empty, select **Rewind** and change your reservoir and infusion set.
5. Monitor your blood glucose closely.
6. If you have followed these steps and receive another NO DELIVERY alarm, call our 24 Hour HelpLine.



### NO RESERVOIR

**Reason:** The reservoir is not inserted correctly or no reservoir has been inserted. Your pump is not delivering insulin.

**Action:** Clear the alarm by pressing **ESC**, then **ACT**. Check that the reservoir is inserted correctly.



## OFF NO POWER

**Reason:** The battery is dead. Insulin delivery has stopped.

**Action:** Clear the alarm by pressing **ESC**, then **ACT**. Replace the battery immediately. Follow the directions on the screen. Check to make sure that the time is correct on the screen. Reset the time if necessary.



## RESET

**Reason:** Your pump settings were cleared (Clear Settings function), and the settings have not been reprogrammed. Insulin delivery has stopped.

**Action:**

1. Clear the alarm by pressing **ESC**, then **ACT**.
2. Reprogram your pump settings, as prescribed by your healthcare professional.



## THRESH SUSPEND (THRESHOLD SUSPEND)



**WARNING:** The Threshold Suspend feature cannot be used to prevent or treat hypoglycemia. Patients should always respond to Threshold Suspend sirens/alarms when possible and perform a self-monitor blood glucose (fingerstick glucose test with a meter). Patients should follow the advice of their healthcare providers in treating hypoglycemia and hyperglycemia.

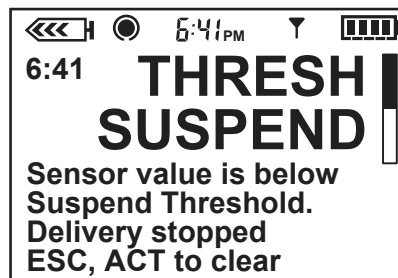



**Reason:** When your sensor glucose value is at or below the Suspend Threshold, the THRESH SUSPEND alarm screen appears, and **all insulin delivery stops**. A siren starts immediately to get your attention or to get help from others if you are unable to respond to the alarm. You can temporarily silence the alarm by pressing any button, after two minutes the pump will again siren. The alarm will stay on the pump screen. However, to clear the alarm, you must press **ESC** then **ACT**.

**Action:**

If you are able to respond to the alarm, follow the steps below. If you are unable to respond to the alarm, skip to the next section on *page 211*.

1. Press **ESC** then **ACT** to clear the alarm.

If you clear the alarm within two minutes, the THRESHOLD SUSPEND/CHECK BG screen appears.

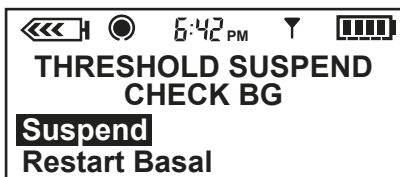

If you do not clear the alarm within two minutes, a new screen appears with the following message: **I have diabetes, call for emergency assistance. To clear ESC then ACT.**

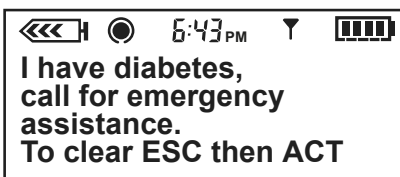

After clearing the screen, the THRESHOLD SUSPEND/CHECK BG screen appears asking you to select either **Suspend** (to keep the insulin delivery suspended) or **Restart Basal** (to resume basal insulin delivery).

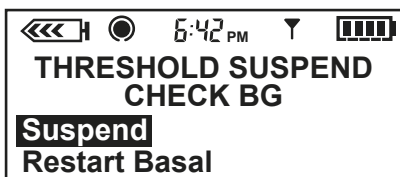

2. If you choose to keep insulin delivery suspended, on the THRESHOLD SUSPEND/CHECK BG screen, select **Suspend** and press **ACT**.

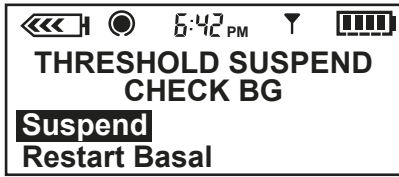

Your pump will stay suspended for two hours and then resume basal delivery.



3. Check your BG and treat as appropriate.



**Note:** If you decide to resume basal insulin delivery after you have selected Suspend, press **ACT** to display the Threshold Suspend screen and select **Restart Basal**.

4. If you choose to restart basal insulin delivery, on the THRESHOLD SUSPEND/CHECK BG screen select **Restart Basal**, then press **ACT**.



The pump resumes delivering basal insulin and displays the following message: Basal delivery is resumed. Check BG. Press any key to cont.

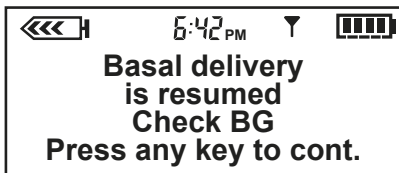

Once basal insulin delivery has resumed, and if your sensor glucose value is at or below the Suspend Threshold, your THRESH SUSPEND alarm will re-trigger based on your Low Repeat setting. See *Setting the Low Repeat*, on page 133 for more information.



**Note:** If you have cleared the Threshold Suspend (THRESH SUSPEND) alarm, and basal insulin delivery has resumed, the pump will resume delivering the basal rate (standard, pattern or temporary) that is programmed to be active for that time. A bolus will not restart. For more information about basal rates, see *Basal patterns*, on page 110.

**If you are unable to respond to the alarm:**

Two minutes after the THRESH SUSPEND alarm is triggered and insulin delivery is stopped, a new screen appears with the following message: **I have diabetes, call for emergency assistance. To clear ESC then ACT.**

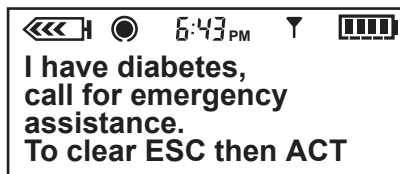

Two hours after the first THRESH SUSPEND alarm, the pump resumes delivering basal insulin and displays the following message: **I have diabetes, call for emergency assistance. Threshold Suspend canceled, check Status. ESC-ACT to cont.**

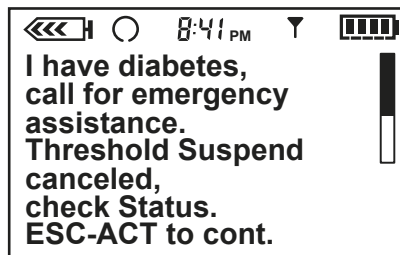

If your sensor glucose is still at or below your Suspend Threshold four hours after resuming basal delivery, your pump will again suspend your basal insulin delivery.

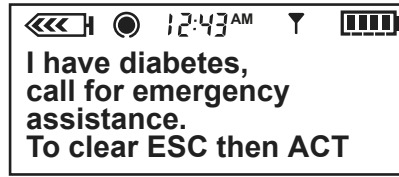

If the THRESH SUSPEND alarm has not been cleared, your pump will continue to siren.



**Note:** If you have not responded to the Threshold Suspend (THRESH SUSPEND) alarm after two hours, insulin delivery will resume at the standard or pattern basal rate that is programmed to be active at the time insulin delivery is resumed. Any programmed temporary basal rate and bolus are cancelled. For more information about basal rates, see *Basal patterns*, on page 110.



## WEAK BATTERY

**Reason:** The battery voltage is less than full strength. The pump will suspend insulin delivery until you clear the alarm. After you clear the alarm, the pump will operate normally, with a decreased battery life. See *Inserting the battery* in *The basics* chapter for more information.

**Action:** Clear the alarm by pressing **ESC**, then **ACT**. Consider inserting a new battery. When replacing your battery, always insert a new battery in the pump.



## Alerts

An alert makes you aware of a situation that may require your attention. An alert is less serious than an alarm. When an alert condition exists, the pump is placed in Special mode and an open circle displays on the pump screen.

**Question:** Why are alerts important?

**Answer:** Your pump monitors activities and will alert you if a Special mode is active. Some alerts are a normal part of pump therapy, such as an active temporary basal. There are alerts that indicate a condition that is outside normal pump activity. For example, your pump notifies you with an alert when you need to replace the reservoir (LOW RESERVOIR) or replace your pump battery (LOW BATTERY).

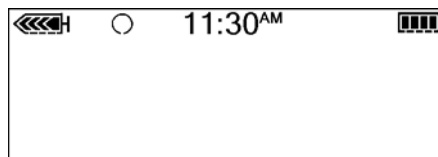

## What to do

When your pump beeps or vibrates notifying you that an alert condition exists:

1. Read and follow the instructions on the screen. Press **ESC**, then **ACT** to clear the alert message.
2. Check the STATUS screen to determine what caused the alert.
3. If the condition is due to a low battery, replace the battery.
4. If the condition is due to a low reservoir, monitor the reservoir volume frequently and change the reservoir when appropriate. Make sure you have a new reservoir, infusion set and vial of insulin with you.

## Pump alert conditions

Listed below are alert conditions that are outside normal pump activity, along with reasons they appear, and suggested steps for resolution.



### LOW RESERVOIR

**Reason:** Your reservoir is low on insulin, according to the number of hours or units set in the Low Reservoir warning.

**Action:** Press **ESC**, then **ACT** to clear the alert message. Change the reservoir soon.



### LOW BATTERY

**Reason:** Your battery is low on power. If you get this alert, **do not go to sleep** without replacing the battery. The backlight, the remote, and meter functions are disabled during a LOW BATTERY condition. If the alert type is set to Vibrate, the pump will change to the audio alert Beep-medium.

**Action:** Press **ESC**, then **ACT** to clear this alert before you replace your battery. Remove the old battery and insert a new battery.

## MISSED BOLUS

**Reason:** You have not delivered a bolus during the time period you specified in the Missed Bolus Reminder feature.

**Action:** Press **ESC**, then **ACT** to clear the alert message. Set a meal bolus if needed.

## Sensor alert conditions

Sensor alerts are notifications related to your sensor glucose readings, as well as the sensor feature settings you have entered into your pump. In order for the pump to warn you of a sensor glucose condition, you must enter your sensor settings into your pump, turn on the glucose alerts, and prepare the sensor for communication. See the *Sensor features* chapter for setup information.

Listed below are alerts that you may encounter while using the sensor feature of your pump, reasons why they appear, and how to resolve the alert condition.

## ALERT SILENCE

**Reason:** One or more glucose alerts occurred during the time that the Alert Silence feature was turned on.

**Action:** Press **ESC**, then **ACT** to clear the alert. Check the SENSOR ALERT HISTORY screen for the recorded glucose alert information. See the *Sensor alert history* section in the *Using your sensor* chapter for details.

## CAL ERROR

**Reason:** An error occurred when entering a new meter BG measurement to calibrate the system. Some possible causes are:

- An incorrect blood glucose number was entered from the meter into the pump.
- The entered blood glucose measurement was not current.
- Your blood glucose is rising or falling rapidly.
- The sensor needs more time to stabilize after being inserted.

- The sensor is no longer reading the glucose correctly.

**Action:** Follow the guidelines in the *Calibrating the sensor* section in the *Sensor features* chapter to enter a new meter BG for calibration. If you receive a Cal Error on your second calibration, a CHANGE SENSOR alert will occur. Call our 24 Hour Helpline if you have questions.

## CHANGE SENSOR

**Reason:** You may receive this alert after you receive two Cal Errors in a row, without the Cal Errors, or when initializing your sensor.

**Action:**

- If the alert resulted from two Cal Errors in a row, replace the sensor.
- If the alert happened without two Cal Errors, use the transmitter's tester to make sure your transmitter is working properly. See *Testing the transmitter, on page 228*.
- If you received this alert during initialization, you may be able to resolve this alert without replacing your sensor. Call our 24 Hour Helpline for further assistance.

## CHARGE TRANSMTR

**Reason:** The transmitter battery is depleted.

**Action:** Press **ESC**, then **ACT** to clear the alert message. Recharge your transmitter immediately. See your transmitter user guide for charging instructions.

## FALL RATE

**Reason:** The sensor glucose measurements are falling at a rate that is equal to or faster than the Set Fall Rate Limit you selected for the alert. The pump plays two consecutive tones, in falling pitch, if an audible beep has been selected as the alert type.

**Action:** Press **ESC**, then **ACT** to clear the alert message. Check your BG and treat as necessary, following the instructions from your healthcare professional. Continue to monitor your BG.



## HIGH PREDICTED

**Reason:** The sensor glucose measurements may **reach or go above** your High Glucose Limit in the length of time you selected for the High Predictive alert. The pump plays three consecutive tones, in rising pitch, if an audible beep has been selected as the alert type.

**Action:** Press **ESC**, then **ACT** to clear the alert message. Check your BG and treat as necessary, following the instructions from your healthcare professional. Continue to monitor your BG.



## HIGH XXX MG/DL (XXX = SG measurement)

**Reason:** The sensor glucose number is higher than or equal to your high glucose limit. If you do not set a High Glucose Limit and do not set the glucose alerts ON, then you will not get a High sensor glucose alert. The pump plays four consecutive tones, in rising pitch, if an audible beep has been selected as the alert type.



**Note:** If your high sensor glucose alert is enabled, and your sensor glucose is higher than 400 mg/dL, then you will continue to receive high glucose alerts.

**Action:** Press **ESC**, then **ACT** to clear the alert message. Check your BG and treat as necessary, following the instructions from your healthcare professional. Continue to monitor.



## LOST SENSOR

**Reason:** The pump has not received a signal from the transmitter. **Do not disconnect the transmitter from the sensor.**

**Action:**

1. Make sure that the sensor is inserted correctly.
2. Check the REVIEW SETTINGS screen to make sure that the transmitter ID entered into the pump matches the ID on your transmitter:

**Main > Sensor > Review Settings**



3. Check the transmitter and sensor connection. Touch the inserted sensor at the back of the assembly to prevent movement and push the transmitter firmly:
  - a. If you hear a click, and if the sensor has had enough time to become hydrated, the green light on the transmitter will flash within 10 seconds. If you see the green light, the alert was due to the transmitter and the sensor not being connected together.
  - b. If you hear a click, but do not see a green light on the transmitter, check to make sure that the transmitter is charged.
  - c. If you do not hear a click when you check the connection, the alert was due to a transmission problem. Bring the pump closer to the sensor and transmitter.
4. Use the **Find Lost Sensor** function to find your sensor (see the *Troubleshooting sensor features* section):

Main > Sensor > Link to Sensor > Find Lost Sensor



### LOW PREDICTED

**Reason:** The sensor glucose measurements may **reach or go below** your Low Glucose Limit in the length of time you selected for the Low Predictive alert. The pump plays three consecutive tones, in falling pitch, if an audible beep has been selected as the alert type.

**Action:** Press **ESC**, then **ACT** to clear the alert message. Check your BG and treat as necessary, following the instructions from your healthcare professional. This alert recurs if your sensor glucose is still approaching your Low Alert Limit after Snooze time ends.



### LOW TRANSMTR

**Reason:** The transmitter battery is close to running out of power. This alert will repeat daily at noon while this condition exists. The transmitter will continue sending sensor signals for several hours and may last for several days until the battery becomes depleted. Recharge your transmitter before the battery becomes depleted, to avoid damaging the transmitter.

**Action:** Press **ESC**, then **ACT** to clear the alert message. Recharge your transmitter as soon as possible. See your transmitter user guide for charging instructions.



### **LOW XX MG/DL (XX = SG measurement)**

**Reason:** The sensor glucose number is equal to or lower than your low glucose limit. If you do not set a Low Glucose Limit and do not set the glucose alerts ON, then you will not get a low sensor glucose alert. The pump plays four consecutive tones, in falling pitch, if an audible beep has been selected as the alert type.



**Note:** If your low sensor glucose alert is enabled, and your sensor glucose is below 40 mg/dL, then you will continue to receive low glucose alerts.

**Action:** Press **ESC**, then **ACT** to clear the alert message. Check your BG and treat as necessary, following the instructions from your healthcare professional. Continue to monitor your BG.



### **METER BG NOW**

**Reason:** A meter BG measurement is needed immediately to calibrate your sensor so that you can continue receiving sensor glucose readings.

**Action:** Press **ESC**, then **ACT** to clear the alert message. Take and enter a meter blood glucose measurement. Follow the guidelines in the *Calibrating the sensor* section in the *Sensor features* chapter.



### **METER BG BY**

**Reason:** A meter BG measurement must be entered by the time that is shown to calibrate your sensor. The METER BG BY alert is also known as the CAL REMINDER alert.

**Action:** Press **ESC**, then **ACT** to clear the alert message. Enter a blood glucose measurement to avoid a METER BG NOW alert.

 **RISE RATE**

**Reason:** The sensor glucose measurements are rising at a rate that is equal to or faster than the Set Rise Rate Limit you selected for the alert. The pump plays two consecutive tones, in rising pitch, if an audible beep has been selected as the alert type.

**Action:** Press **ESC**, then **ACT** to clear the alert message. Check your BG and treat as necessary, following the instructions from your healthcare professional. Continue to monitor your BG.

 **SENSOR END**

**Reason:** The sensor has reached the end of its life.

**Action:** Press **ESC**, then **ACT** to clear the alert message. Replace your sensor. The sensor has a maximum life of 144 hours (6 days). The 144-hour life span of the sensor begins when the pump receives the first METER BG NOW alert.

 **SENSOR ERROR**

**Reason:** The sensor signals are either too high or too low.

**Action:** You do not need to change the sensor. Clear the alert. If the alert persists, test your transmitter with the tester.

 **WEAK SIGNAL**

**Reason:** Occurs when the pump does not receive data from the transmitter for a pre-defined period of time (as set in Weak Signal).

**Action:** Press **ESC**, then **ACT** to clear the alert message. Move the pump closer to the transmitter or move the transmitter and the pump to the same side of your body.



# 14

troubleshooting



# 14

## Troubleshooting

This chapter contains procedures and information to help you understand and address specific conditions that might occur with your pump. For a complete list of alarms and alerts that may appear on your pump, see the *Alarms and alerts* chapter.



**Note:** Read your warranty statement included with your pump for information on what is covered during your warranty period.

### Troubleshooting pump issues

#### My pump has a NO DELIVERY alarm

When a NO DELIVERY alarm occurs, it means that insulin delivery has stopped. Your pump is not broken, but it has detected that something is preventing insulin from being delivered. Do the following steps:

1. Check to see if your infusion set has become dislodged or kinked.
2. Check your blood glucose and follow your safety guidelines for treating high glucose if necessary.
3. Clear the alarm by pressing **ESC**, then **ACT**. A screen appears with two choices: **Resume** and **Rewind**.
4. Make sure that there is insulin in your reservoir.
  - a. If you identified and fixed a kink in your tubing, select **Resume**.
  - b. If the reservoir is empty, select **Rewind** and change your reservoir and infusion set.

5. Monitor your blood glucose closely.
6. If you have followed these steps and receive another NO DELIVERY alarm, call our 24 Hour HelpLine.

### What is a CHECK SETTINGS alarm?

This alarm occurs after an E-alarm or after you clear your pump. It is advising you to make sure that all your settings are correct. A CHECK SETTINGS alarm occurs after any of these actions:

- All user settings were cleared (set back to their defaults) because there was an E-error alarm.
- The Clear Settings function was performed.
- After you rewind when practicing without a reservoir when you first get your pump. In this case, it is just a reminder to make sure all your settings are programmed before you begin using the pump with insulin.

### What happens if I leave the pump battery out too long?

If you leave the pump battery out too long (more than five minutes) you may receive a BATT OUT LIMIT alarm message when you insert the new battery. Do the following steps:

1. Set your pump clock to the correct time, date, and year.
2. Check to make sure that all your settings, such as basal rate, are set as desired. If need be, reapply your last saved settings to the pump by using the **Restore Settings** option under **User Settings** in the UTILITIES MENU (you can only use this option if you have previously saved your pump settings). See the *Restoring the settings* section in the *Utilities* chapter.
3. Check the ALARM HISTORY screen and the STATUS screen for any alarms or alerts that may still need attention.

If you leave the battery out for more than three or four days, you may receive an A17 and A47 alarms when you insert a new battery. Do the following steps:

1. Clear the A17 and A47 alarms, by pressing **ESC**, then **ACT**.
2. Set your pump clock to the correct time, date and year.



3. Check to make sure that all your settings, such as basal rate, are set as desired. If need be, reapply your last saved settings to the pump by using the **Restore Settings** option under **User Settings** in the UTILITIES MENU (you can only use this option if you have previously saved your pump settings). See the *Restoring the settings* section in the *Utilities* chapter.
4. Check the ALARM HISTORY screen and the STATUS screen for any alarms or alerts.

### Why doesn't my pump battery last very long?

A short battery life does not mean that something is wrong with your pump. Battery life in your pump is variable and based on the conditions below:

- The brand of battery you use (we recommend Energizer).
- The storage or handling of the battery before use (avoid high or low temperatures).
- The usage of pump in cold temperatures; this may shorten the battery life.
- The usage of your pump, such as how often the buttons are pushed, the number of alerts/alarms and set changes.
- The amount of insulin the pump is delivering.
- The usage of some features. The backlight, vibrate, sensor, remote control, and meter options decrease battery life.

### My screen appears distorted

The screen may appear distorted or have a rainbow-like appearance if you are wearing polarized sunglasses, are in bright sunlight, or in extreme high or low temperatures. If your screen appears distorted:

- Take off your sunglasses.
- Move into the shade.
- Make sure your pump is not in direct heat (next to a heater) or cold (worn on the outside of your clothing on a very cold day).
- **Do not return the pump:** this is a normal property of this type of screen on any device.

## The pump is asking me to rewind

This is normal after any of the following:



- Any E-alarms.
- The Clear Settings function.
- A NO DELIVERY alarm (during the Reservoir + Set sequence).

## My bolus stopped

The Bolus Stopped error can occur if the battery cap is loose or the pump was bumped or dropped during a bolus. It can also happen if the pump receives a static shock. As a safety measure, the pump stops the bolus when this happens.

1. If you dropped your pump, visually inspect it to make sure that it is not damaged in any way.
2. Review your bolus history and reprogram the remaining bolus, if needed.

## My pump buttons are not acting right during a bolus

If the   or  buttons are pressed and held down while a bolus is being delivered, the screen will freeze on that amount. Once the button is released, the units will ramp up to the amount delivered so far. Pressing and holding down the button will not stop the delivery of a bolus.

## My pump will not display my blood glucose reading from my meter

1. Make sure you are using the correct meter (a blood glucose meter supported by MWT1 technology). Your pump will communicate with this meter only.
2. Make sure your meter's RF (radio frequency) feature is on and working correctly.
3. Make sure the meter option in your pump is set to **On** and you have set the meter ID number correctly on the pump.
4. Make sure your pump does not have a low battery alert condition.
5. Make sure the meter is within 4 feet (1.2 meters) of the pump without anything in between such as another person, a wall, etc.

6. Make sure there is no RF (radio frequency) interference from other electronic devices that could prevent communication. These devices can include some cell phones, cordless phones, televisions, computers, radios, other pumps, meters, and pump remote controls. To restore communication, simply move away from these other types of devices, or turn them off.
7. Your pump will not show another reading. Make sure the pump is idle and the HOME screen is blank.
8. If your pump still does not receive your blood glucose reading from the meter, use the up/down buttons to manually enter your blood glucose (in the ENTER BG screen).

### I dropped my pump

Take care to protect your pump from being dropped.

1. Check that all connections are still tightly in place.  
If you notice that the drive support cap is loose, or sticking out, discontinue use of the pump. **Do not press on the drive support cap. Pushing on the drive support cap may result in unintended insulin delivery, which can cause hypoglycemia.** See *General warnings* in the *Introduction* chapter for more information.
2. Check the LCD, keypad and pump case for cracks or damage.
3. Check the infusion set, including the tubing connector and tubing for cracks or damage.
4. Review the status screen, basal rates, and other pump settings.
5. Perform the Selftest procedure located in the UTILITIES MENU.
6. If the selftest does not complete successfully, call our 24 Hour HelpLine for assistance.

### I submerged my pump in water

Your pump is designed to resist accidental contact with water. Do not submerge in water during bathing, showering, swimming, or other water activities.

1. Pat the outside of the case until dry.

2. Open the reservoir compartment and check the compartment and reservoir for water. If wet, dry it completely within 10 minutes of exposure to water. Exposure to liquids, including water or insulin can corrode the mechanism.
3. Dry the reservoir completely. To avoid damaging your pump, do not place a wet reservoir in the pump.
4. Do not use hot air to dry your pump. This may damage your pump's internal electronics.
5. Check the battery compartment and the battery—if wet, dry them completely before using the pump.
6. Perform a selftest.
7. If you believe that water has entered your pump or you observe any other possible pump malfunction, please check your blood glucose, treat high blood glucose (if necessary) with an injection, and contact our 24 Hour HelpLine at 1-800-646-4633 for further assistance. Symptoms of high blood glucose include fatigue, excessive thirst, and nausea. You should always contact your healthcare professional if you experience excessively high or low blood glucose levels, or if you have any questions about your care.

### I cannot get to the USER SETTINGS screen

If you press **ACT** when you have **User Settings** highlighted, the following message appears: This feature is not normally accessible. To access, consult your User Guide.

#### To get to the USER SETTINGS screen:

1. Go to the UTILITIES MENU screen.  
**Main > Utilities**
2. Select **User Settings**. Hold down **↻B** and press **ACT**.
3. See the *User settings* section in the *Utilities* chapter for information about the menu options.

## Troubleshooting transmitter issues

### Testing the transmitter

The tester acts like a sensor. If you get sensor-related alerts, use the tester to make sure that the transmitter is working.

## Connecting the tester

1. Hold the transmitter and the tester as shown. Line up the flat side of the tester with the flat side of the transmitter.

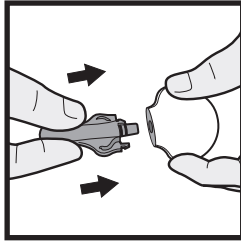

2. Push the tester into the transmitter until the flexible side arms of the tester click into the notches on both sides of the transmitter.
3. If the transmitter is properly connected, the green light on the Transmitter will flash within 10 seconds. The Sensor feature must be turned **On**. Go to the RECONNECT OLD SENSOR screen to start your sensor.

**Main > Sensor > Link to Sensor > Reconnect Old Sensor**

You should see the sensor icon  on the pump screen, which means that the transmitter and the tester are communicating.

4. Within the next seven to eight minutes, go to the SENSOR STATUS screen to look for the Sensor ISIG value:
  - a. The sensor ISIG value on this screen should be between 24.00–29.00 nA. This range of ISIG values means that the transmitter electronics are working properly. Since the transmitter is sending signals correctly, the sensor must have caused the alert. Remove and discard the sensor. Insert a new sensor in a new site.
  - b. If you see a Sensor ISIG value that is less than 24.00 nA or more than 29.00 nA, contact our 24 Hour HelpLine. It may be time to replace your transmitter.

## Disconnecting the tester

1. Hold the transmitter body as shown and pinch the side arms of the tester.

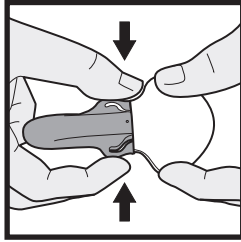

2. With the tester arms pinched, gently pull the transmitter away from the tester. To save transmitter battery life, do not leave the tester connected after testing.

## Troubleshooting sensor features

### I want to reconnect an old sensor

You should only use this feature if you have disconnected the sensor from the transmitter and have to reconnect them.

#### To reconnect old sensor:

1. Go to the RECONNECT OLD SENSOR screen.  
**Main > Sensor > Link to Sensor > Reconnect Old Sensor**
2. Press **ACT** in the RECONNECT OLD SENSOR screen.
3. Connect the transmitter to your sensor now if you have not already done so. If the screen times out, do **not** disconnect the sensor. Start from step 1 again.
4. The SENSOR READY 2 HRS screen appears. Press any button to continue. An alert will sound in two hours when a meter BG is required for calibration.

### I want to find a lost sensor

#### If you receive a Lost Sensor alert:

1. Relocate the pump closer to the sensor, and go to the LINK SENSOR MENU.  
**Main > Sensor > Link to Sensor**
2. Select **Find Lost Sensor**, then press **ACT**.

3. The SENSOR READY 15 MIN screen appears. Press any button to continue. An alert will sound in 15 minutes when a meter BG is required for calibration.

### I disconnected my sensor during Threshold Suspend

If the sensor loses communication from the pump (either loss of signal or disconnected) during Threshold Suspend:

- The pump will remain in Threshold Suspend until the two hour suspension is complete.
- Basal insulin delivery will resume after the two hour suspension.
- Once the pump resumes basal insulin delivery, further Threshold Suspend can happen only if the sensor is reconnected, the communication between transmitter and the pump is reestablished, and the sensor is calibrated.

There are three different scenarios:

- If you have not disconnected the sensor, but the communication between the transmitter and the pump is lost for less than 45 minutes, the pump may automatically reestablish communication with the transmitter.
- If you have not disconnected the sensor, but the communication between the transmitter and the pump is lost for 45 minutes or more, the pump will stop trying to communicate with the transmitter. If you want to reestablish communication, you **must** exit the Threshold Suspend. \* Follow the procedure *I want to find a lost sensor, on page 230*.
- If you have disconnected the sensor from the transmitter, in order to reestablish communication after you have reconnected the sensor, you **must** manually exit the Threshold Suspend. \* To reestablish the communication, follow the procedure *I want to reconnect an old sensor, on page 230*. After two hours of sensor initialization, you must enter meter BG to calibrate the sensor. Then, 10 to 15 minutes after calibration is done, glucose values will again be displayed and the pump can enter Threshold Suspend again if all Threshold Suspend conditions are met.

\* To manually exit the Threshold Suspend, press **ESC** and then **ACT** and select **Restart Basal**.

Once the communication is reestablished, pump can enter Threshold Suspend again if all Threshold Suspend conditions are met.





15

■ maintenance



# 15

## Maintenance

It is recommended that you read your warranty statement included in this user guide for information about what is covered during your warranty period.

### Battery

The pump uses a single 1.5 V AAA alkaline battery, size E92, type LR03. As a safety measure, Medtronic Diabetes has designed the pump to only accept a NEW battery. If you insert a used battery, the FAILED BATT TEST alarm may be triggered. Refer to the *Inserting the battery, on page 23* for instructions.

Certain features on the pump use a lot of battery power. Your battery will need to be replaced more frequently if you use these features:

- Remote control
- Meter
- Backlight
- Vibrate alert type setting

### Storage

If you have to remove and store your pump, it is recommended that you store it with the battery in place. Keep a record of your current basal rates. To preserve battery life, reset the basal rates to 0 (zero), turn off the remote and meter options, and set the Auto-off to dashes or zeroes.

## Cleaning your pump



**Caution:** Always keep the reservoir compartment dry and away from moisture to avoid damaging your pump.

Make sure you have the following supplies ready for cleaning your pump: three or four small, clean, soft cloths, a mixture of water with a mild detergent, clean water, 70% alcohol, and a few clean cotton tips and cotton balls.

### To clean your pump:

1. Dampen a cloth with water mixed with a mild detergent.
2. Using the cloth, wipe the outside of the pump.
3. Dampen a clean cloth with water and wipe to remove any detergent residue.
4. Dry with a clean cloth.
5. Wipe your pump with a 70% alcohol wipe for disinfection.
6. Using a dry clean cotton tip, remove any battery residue from the battery cap.
7. Using a dry clean cloth, remove any battery residue from the battery compartment opening.

## Cleaning the transmitter

For details on how to clean the transmitter, see your transmitter user guide.

## Cleaning the Serter

For details on how to clean the Serter, see your Serter user guide.

# 16

■ pump specifications



# 16 Pump specifications

This section provides detailed information on specifications related to your pump. The safety features of your pump are individually listed and described.

## Alarms and error messages

- Indicators: audible tone (beep) or vibration (silent).
- All alarms and errors show messages on the pump's screen and provide instructions on what to do. Unresolved alarms will escalate to siren mode for added safety.

## Alarm history

Maximum records shown: 36

## Audio frequency

Name	Frequency (+/- 25%)
Alarm	1850 Hz
Escalated alarm (siren)	2.5 kHz, followed by 3.2 kHz
Alert	1.8 kHz, followed by 2.1 kHz and 1.8 kHz
Threshold Suspend alarm	2.5 kHz, followed by 3.2 kHz
High Glucose alert	2.5 kHz, followed by 2.79 kHz, 2.98 kHz and 3.2 kHz
Low Glucose alert	3.2 kHz, followed by 2.98 kHz, 2.79 kHz and 2.5 kHz
Predictive High Glucose alert	2.5 kHz, followed by 2.98 kHz and 3.2 kHz

<b>Name</b>	<b>Frequency (+/- 25%)</b>
Predictive Low Glucose alert	3.2 kHz, followed by 2.98 kHz and 2.5 kHz
Rising rate of change alert	2.5 kHz, followed by 3.2 kHz
Falling rate of change alert	3.2 kHz, followed by 2.5 kHz

## Backlight

- LCD (Liquid Crystal Display) type
- Time-out: 30 seconds

## Basal

- Delivery: 0.025–35 units/hour (maximum units: 35/hour)
- Factory maximum setting: 2.0 units/hour
- 3 patterns maximum, each with 48 rates
- Increments:
  - 0.025 units for basal amounts in the range of 0.025 to 0.975 units
  - 0.05 units for basal amounts in the range of 1 to 9.95 units
  - 0.1 units for basal amounts of 10.0 units or larger

## BG Target

Maximum targets: 8

- Range: 60–250 mg/dL
- Warning limits: less than 90 or greater than 140 mg/dL

## Bolus delivery

- Insulin delivered/stroke:
  - 0.025 units for bolus amounts in the range of 0.025 to 0.975 units
  - 0.05 units for bolus amounts larger than 0.975 units
- Fluid delivered/stroke: 0.25  $\mu$ L (microliter) for 0.025 unit pump stroke; 0.5  $\mu$ L for 0.05 unit pump stroke



## Maximum bolus

- Range: 0.0–25.0 units

## Bolus history

Maximum records shown: 24

## Bolus units

Increments: Based on selected scroll rate

## Bolus Wizard feature

See the *Bolus Wizard feature specifications* section in this chapter for information.

## Carb ratios

Maximum ratio settings	Range	Warning limits
8	1–200 grams/u	less than 5 or greater than 50 grams/u
	0.075–15.0 u/exch	less than 0.3 or greater than 3.0 u/exch

## Carb units

The food entry when using Bolus Wizard feature:

- grams: 0–300 (increments: 1 gram)
- exchanges: 0.0–20 (increments: 0.5 exch)

## Daily totals

Maximum records shown: 32 days of data, maximum display: 999.975 units/day.

Daily delivery accuracy: 0.025 units.

## Default screen

The HOME screen. For most screens, if no buttons are pressed for 30 seconds, the pump returns to this screen.

## Delivery accuracy

Insulin pumps need to be tested at a typical rate per medical device standards. An intermediate rate of 1.0 unit per hour was selected after an analysis of typical insulin usage of type 1 diabetes patients.

Pumps are programmed with the 1.0 unit per hour rate and then measured for delivery accuracy over a period of 24 hours, in a laboratory setting.

- Testing has confirmed that the delivery accuracy for the maximum/minimum bolus/basal amounts are within the +/-5 percent of the programmed value.
- All normal boluses will be delivered within a maximum of six minutes.
- Displacement (piston) accuracy: +/-2 percent.

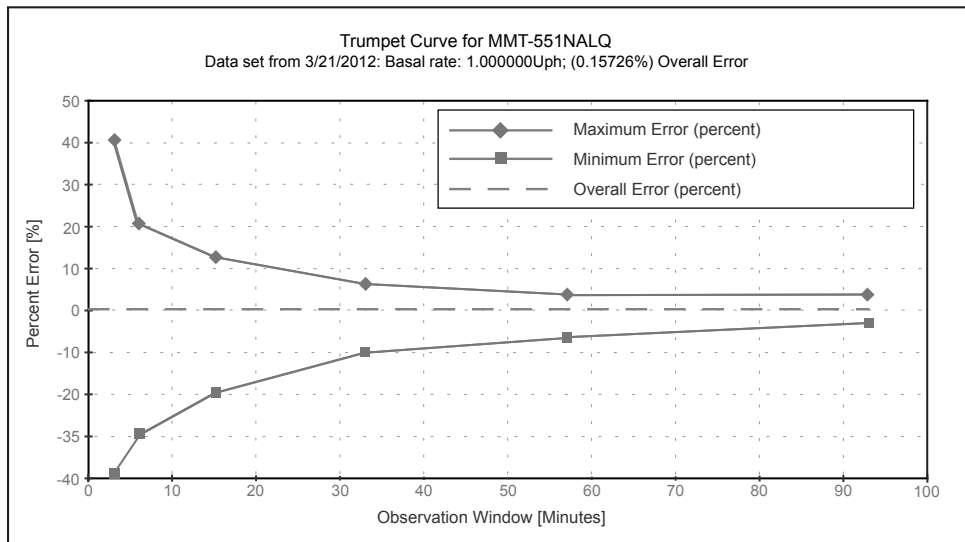

## Pump motor

The pump motor has a unique, patented design with an integrated safety check system. The system delivers in precise increments.

## Normal bolus

Range 0.025–25.0 units of insulin (limited by maximum bolus setting).

## Dual Wave bolus

Delivers a Normal bolus followed by a Square Wave bolus (limited by maximum bolus).

## Easy bolus

- Features programming using audible tones (or vibrate pulses) in user-defined increments.
  - Beep mode range: 0 to maximum bolus
  - Vibrate mode range: 0 to 20 steps or maximum bolus, whichever comes first
- Factory default: off
- Default step increment: 0.1 unit
- Step size  $\leq$  maximum bolus.
- Adjustable step size: 0.1 to 2.0 units per step.
- Accessible from the remote control or pump buttons.

## Filling the infusion set

- Filling the cannula: up to 10 units (limited by maximum bolus)
- Filling the tubing: warning at 30 units, then at each 10 units thereafter.
- Fill rate: 1 to 5 units/second.
- Insulin used to fill the infusion set is not counted in daily totals but is recorded separately in the Reservoir + Set history.

## Infusion pressure

Maximum infusion pressure and occlusion pressure: 13.7 PSI (94.46 kPa).

## Insulin sensitivity

- Maximum settings: 8
- Factory default: 50 mg/dL/u
- Range: 10–400 mg/dL/u
- Warning limits: less than 20 or greater than 100 mg/dL/u

## Low resv (reservoir) warning

Programmable warning that notifies you with an alert when either a specified number of units remain in the reservoir or a specified amount of time remains before the reservoir will be empty.

The warning works the same for both the 180-unit and the 300-unit reservoirs.

time:	2–24-hours, and @ 1:00 hour before empty	08:00 hours (default when time is selected)
units:	5–50 units, and @ half of the remaining amount	20 units (factory default)

## Meter value

The BG measurement received from the meter. Appears in the ENTER BG screen during bolus programming. Appears on the screen when the pump is idle at the HOME screen.

- Expiration: 12 minutes
- Range: 20–600 mg/dL
- Maximum meter ID entries: 3

## Occlusion detection

When occlusion is detected, the NO DELIVERY alarm occurs. The occlusion alarm is triggered by an average of 2.95 units of missed insulin. The pump is intended for use with U100 insulin. This table shows occlusion detection for three different situations when using U100 insulin.

Rate	Minimum time before alarm	Typical time before alarm	Maximum time before alarm
bolus delivery (10 units at 2 u/min)	43 seconds	60 seconds	78 seconds
basal delivery (1.0 u/h)	2.25 hours	3.53 hours	4.7 hours
basal delivery (0.025 u/h)	98 hours	136.03 hours	221 hours

## Percent temp basal

Default value: 100% of basal programming

## Power supply

The pump is powered by a standard 1.5 V AAA alkaline battery, size E92, type LR03 (Energizer brand recommended).

## Reservoir + Set history

Maximum records shown: 20 (fill tubing and fill cannula)

## Program safety checks

Maximum infusion with single fault condition: 0.0 units

## Charger size

The dimensions of the charger are:  
1.09 x 1.70 x 2.41 inches

## Charger weight

The weight of the charger is 31.8 grams.

## Pump size

The dimensions of the pump are approximately:

- 551 pump:
  - 2.0 x 3.3 (3.2 at the battery cap) x 0.81 inches
  - 5.1 x 8.3 (8.1 at the battery cap) x 2.1 cm
- 751 pump:
  - 2.0 x 3.7 (3.5 at the battery cap) x 0.82 inches
  - 5.1 x 9.4 (8.9 at the battery cap) x 2.1 cm

## Pump weight

- 551 pump: approximately 95 grams (with battery inserted).
- 751 pump: approximately 104 grams (with battery inserted).

## Remote control size

The dimensions of the remote control are:

1.53 x 2.14 x 0.54 inches

## Remote control weight

The weight of the remote control is 25.1 grams (with battery inserted).

## Sensor size

The dimensions of the sensor are:

2.46 x 2.50 x 1.87 inches

## Sensor weight

The weight of the sensor is 6.25 grams.

## Serter size

The dimensions of the serter are:

2.93 x 1.95 x 2.45 inches

## Serter weight

The weight of the serter is 71.2 grams.

## Transmitter size

The dimensions of the transmitter are:

0.366 x 1.40 x 1.119 inches

## Transmitter weight

The weight of the transmitter is 5.5 grams.

## Remote control

Uses radio signals to allow users to program Normal boluses or to manually suspend/resume their pumps.

## Reservoir

- The user-filled reservoir is made from impact-resistant, insulin-compatible polypropylene.
- MMT-551 pump volume: up to 180 units of U100 insulin
- MMT-751 pump volume: up to 300 units of U100 insulin

## Square Wave bolus

Delivers bolus insulin over a duration of 30 minutes up to eight hours (limited by the Max bolus setting).

## Temporary (temp) basal rate

Allows you to temporarily change the current basal rate for a duration of 30 minutes up to 24 hours (limited by Maximum basal setting). The temp basal rate can be set to either Percent of basal or Insulin rate.

## Time and date screen

12-hour or 24-hour formats. Pump users set the time/date, including the year, month and day. The date is included in the STATUS screen. Time always appears on the top of the screen.

## Environmental conditions

- Pump operating temperature range: from 37°F (3°C) to 104°F (40°C)
- Air pressure range: from 700 hPa to 1060 hPa (from 10.2 PSI to 15.4 PSI)
- Operating humidity range of the case: 20% to 95%. This requirement exceeds EN 60601-2-24:1998, Section 10.2.1b (20% to 90%).

## Radio frequency (RF) communication specifications

- Pump to transmitter frequency: 916.5 MHz; proprietary Medtronic protocol; range up to 6 feet (1.8 meters)
- Pump to meter frequency: 916.5 MHz; proprietary Medtronic protocol; range up to 4 feet (1.2 meters)

- Pump to remote frequency: 916.5 MHz; proprietary Medtronic protocol; range up to 24 inches (approximately 60 cm)

## Quality of service

Common consumer electronic devices that transmit in the same frequency band used by the transmitter may prevent the pump from receiving the glucose information sent by the transmitter. Adherence to the following guidelines will result in a consistent and reliable quality of service:

- Cell phone 12 inches away from pump and meter
- Meter and pump within 4 feet of each other
- Pump and transmitter 6 feet of each other

## Data security

The MiniMed® 530G series insulin pump is designed to only accept radio frequency (RF) communications from recognized and linked devices (you must program your pump to accept information from a specific device).

The MiniMed® 530G series insulin pump and system components (meters and transmitters) ensure data security via proprietary means and ensures data integrity using error checking processes, such as cyclic redundancy checks.

## Status screen

Item	When	What
Active Insulin	(if any)	(Active Ins:) the amount of active insulin, displayed to the next 0.025 U
Alarm Clock*	(appears if scheduled to alarm)	Time set is displayed.
Alert Silence	(if active)	Hi, Lo, Hi/Lo, All with time left
Auto-off	(appears if enabled)	X HR
Basal pattern information	(if active)	Pattern A or B
Battery Status	(always appears)	Normal, Low, Off



Item	When	What
BG meter value (most recent BG value received)	(appears if BG meter is enabled)	XXX mg/dL time and date received
BG Reminder* (Only if enabled)	Time remaining before BG Reminder is set to go off H:MM h (if less than 1 hour, 0:XXh where XX is minutes remaining)	
Block	(if active)	ON
Current date	(always appears)	
Current temp basal information	(if active)	rate (units per hour), duration, time remaining
Last alarm/alert	(if cleared within 24 hours)	(Last:) with the date, time and abbreviation for the most recently cleared alarm/alert
Last bolus information	(appears if at least one bolus was started)	type and units delivered delivery time and date  (S = Square, N = Normal, DN = Normal part of dual wave bolus, DS = Square part of dual wave bolus)
Meter: Disabled	(appears if enabled but battery is low or empty)	
Meter: On	(appears if enabled)	
Missed Bolus Reminder	(if this feature is turned on)	Bolus Before and the time that the reminder is due
Pump model number	(always appears)	
Remote: Disabled	(appears if enabled but battery is low or empty)	
Remote: On	(appears if enabled)	
Reservoir started	(always appears)	date, time, units left, time left
Serial number	(always appears)	
Sensor Demo	(if Demo Mode is selected for the sensor graphs)	SENSOR DEMO: On
Software version	(always appears)	

Item	When	What
Standard basal delivery data	(always appears)	current basal rate (basal 1, basal 2, etc.)
Status of pump	(such as Rewind, manual Suspend, Threshold Suspend, Low Reservoir, Set Time, and so on)	
Time	(always appears)	

\*If all of the Reminders and the Alarm Clock are enabled, only the reminder that is nearest to alarming will appear in the STATUS screen.

## Bolus Wizard feature specifications

There are four different formulas the Bolus Wizard feature uses to estimate a bolus, depending on your current BG. The following formulas apply only when the carb units are in grams.

1. If your current BG is greater than your High BG Target, the Bolus Wizard feature subtracts active insulin from the BG correction estimate, then adds this to the food estimate to get the total bolus estimate. However, if the result of subtracting active insulin from BG correction estimate is a negative number (less than zero), the total bolus estimate is based only on the food estimate.

### Food estimate:

Carb grams ÷ Carb ratio = Units of insulin

### Correction estimate:

(Current BG - High BG Target) ÷ Insulin sensitivity - Active insulin = Units of insulin

### Total bolus estimate:

Food estimate + Correction estimate = Units of insulin

2. If your current BG is less than your Low BG Target, the Bolus Wizard feature adds the BG correction estimate to the food estimate to get the total bolus estimate.

### Food estimate:

Carb grams ÷ Carb ratio = Units of insulin

### Correction estimate:

$(\text{Current BG} - \text{Low BG Target}) \div \text{Insulin sensitivity} = \text{Units of insulin}$

**Total bolus estimate:**

Food estimate + Correction estimate = Units of insulin

- If your current BG is between or equal to your High or Low BG Target, the total bolus estimate is based only on the food estimate.

**Food estimate:**

Carb grams  $\div$  Carb ratio = Units of insulin

**Total bolus estimate = Food estimate**

- If you do not enter a BG, the total bolus estimate is based only on the food estimate.



**NOTES:**

- If a Dual Wave bolus is less than the estimate due to the max bolus limit or a user change, the square (sq) portion is reduced first.
- Based on the Active Insulin Time setting you choose, the pump keeps track of how much insulin is still active in your body. This is shown as Active Ins. or Act. Ins. in the STATUS, SET BOLUS, SET NORMAL BOLUS, SET SQUARE BOLUS, SET DUAL BOLUS TOTAL, and SET EASY BOLUS screens. This prevents stacking of insulin, and lowers the chances of hypoglycemia.
- The active insulin amount is also shown in the Bolus Wizard's ESTIMATE DETAILS screen but is calculated differently than in the above screens. The active insulin amount calculated in the ESTIMATE DETAILS screen includes the insulin that has already been delivered and insulin that is going to be delivered by the active Square Bolus. To show this difference in calculation, the active insulin appears with an asterisk (\*Active Insulin) in this screen.

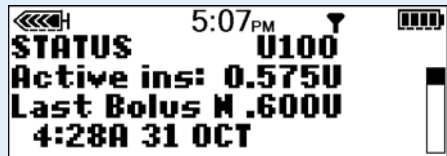

- The Bolus Wizard feature may utilize your current BG measurement, carbohydrate consumption, and active insulin to calculate your estimated bolus.
- Active Insulin Curves

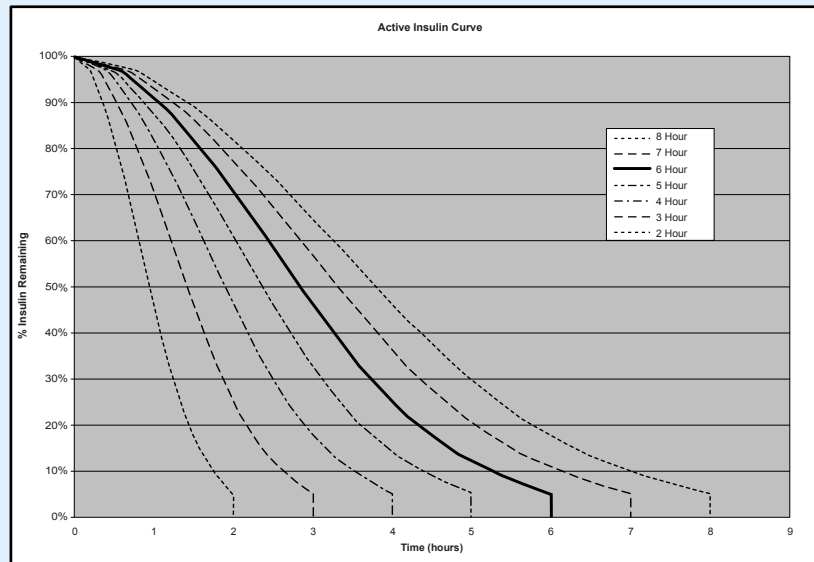

Graph adapted from Mudaliar and colleagues, Diabetes Care, Volume 22, Number 9, Sept. 1999, page 1501.

## Bolus Wizard feature examples

### Settings:

- Carb ratio: 30 grams/unit
  - BG Target: 90–120 mg/dL
  - Insulin Sensitivity: 40 mg/dL/unit
  - Active Insulin Time: 6 Hours
1. No active insulin from previous bolus delivery. User inputs 60 grams of carbs and does not enter BG.

### Food estimate:

Carb grams ÷ Carb ratio = Units of insulin

$$60 \text{ g} \div 30 \text{ g/u} = 2 \text{ units}$$

**Total bolus estimate = Food estimate = 2 units**

2. No active insulin from previous bolus delivery. User inputs 60 grams of carbs and a BG of 200 mg/dL.

**Food estimate:**

$$\text{Carb grams} \div \text{Carb ratio} = \text{Units of insulin}$$

$$60 \text{ g} \div 30 \text{ g/u} = 2 \text{ units}$$

**Correction estimate:**

$$(\text{Current BG} - \text{High BG Target}) \div \text{Insulin sensitivity} = \text{Units of insulin}$$

$$(200 \text{ mg/dL} - 120 \text{ mg/dL}) \div 40 \text{ mg/dL/u} = 2 \text{ units}$$

**Total bolus estimate:**

$$\text{Food estimate} + \text{Correction estimate} = \text{Units of insulin}$$

$$2 \text{ units} + 2 \text{ units} = 4 \text{ units}$$

3. No active insulin from previous bolus delivery. User inputs 60 grams of carbs and a BG of 70 mg/dL.

**Food estimate:**

$$\text{Carb grams} \div \text{Carb ratio} = \text{Units of insulin}$$

$$60 \text{ g} \div 30 \text{ g/u} = 2 \text{ units}$$

**Correction estimate:**

$$(\text{Current BG} - \text{Low BG Target}) \div \text{Insulin sensitivity} = \text{Units of insulin}$$

$$(70 \text{ mg/dL} - 90 \text{ mg/dL}) \div 40 \text{ mg/dL/u} = -0.5 \text{ units}$$

**Total bolus estimate:**

$$\text{Food estimate} + \text{Correction estimate} = \text{Units of insulin}$$

$$2 \text{ units} + (-0.5) \text{ units} = 1.5 \text{ units}$$

4. No active insulin from previous bolus delivery. User inputs 60 grams of carbs and a BG of 100 mg/dL.

**Food estimate:**

$$\text{Carb grams} \div \text{Carb ratio} = \text{Units of insulin}$$

$$60 \text{ g} \div 30 \text{ g/u} = 2 \text{ units}$$

**Correction estimate:**

Correction is 0 because the current BG reading is within the BG Target range.

**Total bolus estimate:**

Food estimate + Correction estimate = Units of insulin

2 units + 0 units = 2 units

5. Previous bolus activity results in a calculation of 1.5 units unabsorbed (active) insulin. User inputs 60 grams of carbs and a BG of 200 mg/dL.

**Food estimate:**

Carb grams ÷ Carb ratio = Units of insulin

60 g ÷ 30 g/u = 2 units

**Correction estimate:**

(Current BG - High BG Target) ÷ Insulin sensitivity - Active insulin = Units of insulin

(200 mg/dL - 120 mg/dL) ÷ 40 mg/dL/u - 1.5 units = 0.5 units

**Total bolus estimate:**

Food estimate + Correction estimate = Units of insulin

2 units + 0.5 units = 2.5 units

6. Previous bolus activity results in a calculation of 3.5 units unabsorbed (active) insulin. User inputs 60 grams of carbs and a BG of 200 mg/dL.

**Food estimate:**

Carb grams ÷ Carb ratio = Units of insulin

60 g ÷ 30 g/u = 2 units

**Correction estimate:**

(Current BG - High BG Target) ÷ Insulin sensitivity - Active insulin = Units of insulin

(200 mg/dL - 120 mg/dL) ÷ 40 mg/dL/u - 3.5 units = -1.5 units\*



**Note:** \*This negative number indicates that active insulin is sufficient to cover the correction that is needed. Thus, correction is 0 units. Active insulin does not reduce the food portion of the estimate.

### Total bolus estimate:

Food estimate + Correction estimate = Units of insulin

2 units + 0 units = 2 units

## Insulin delivery default settings

Menu	Item	Default Setting	Limits	Increments
Bolus Menu:	Bolus Wizard feature:	Off		
	Easy bolus:	Off		
	Easy bolus step:	0.1 u	2.0 u	0.1 u
	Scroll Rate:	0.10 u		0.025 u; 0.05 u; 0.10 u
	Dual/Square bolus:	Off		
	Maximum bolus:	10.0 u		0.0–25.0 u (per single bolus)
	BG Reminder:	Off	0:00–5:00	0:30
Basal Menu:	Patterns:	Off		
	Maximum basal rate:	2.00 u/h	0.000–35.0 u/h	0.025 u (for 0.025–0.975 u/h); 0.05 u (for 1.00–9.95 u/h); 0.1 u (for rates of 10 u/h or more)
	Basal rate:	0.000 u/h		0.025 u (for 0.025–0.975 u/h); 0.05 u (for 1.00–9.95 u/h); 0.1 u (for rates of 10 u/h or more)

Menu	Item	Default Setting	Limits	Increments
	Temp basal type:	U/H	Max basal rate setting	0.025 u (for 0.025–0.975 u/h); 0.05 u (for 1.00–9.95 u/h); 0.1 u (for rates of 10 u/h or more); (or 1%)
<b>Utilities Menu:</b>	Lock Keypad:	Off		
	(Alarm) History:	(no defaults)		
	Alert type:	audio, beep-med		
	Auto-off:	Off		
	Capture Option:	Off		
	Low reservoir warning:	(20) insulin units	<b>if units:</b> 1st @ 5–50 u; 2nd @ half amount remaining <b>(if time:</b> 1st @ 2:00–24:00; 2nd @ 1:00 hour before empty)	20 u (0:30)
	(Time/Date) Time:	12 a.m. (midnight)		
	(Time/Date) Date:	1/1/07		
	(Time/Date) Time format:	12-hour		
	Block:	Off		
	Alarm clock:	Off		
	Remote option:	Off		
	Meter option:	Off		



Menu	Item	Default Setting	Limits	Increments
	User Settings:	(no defaults)		
	Language:	English		

## Bolus Wizard feature default settings

Item	Default Setting	Limits	Increments	Warning Limits
carb units:	grams	—	—	—
ins to carb (or exch) ratio:	15 grams/u or 1 unit/exch	1–200 g/u or 0.075–15.0 u/exch	0.1 g/u for 0–9.9 g/u; 1 g/u for ratios of 10.0 g/u or more (or 0.001 u/exch for 0.075–0.099 u/exch; 0.01 u/exch for 0.10–9.99 u/exch; 0.1 u/exch for 10.0–15.0 u/exch)	5–50 g/u or 0.3–3.0 u/exch
(insulin) sensitivity:	50 mg/dL/u	10–400 mg/dL/u	1 mg/dL/u	20–100 mg/dL/u
BG Target:	100–100 mg/dL	60–250 mg/dL	1 mg/dL	90–140 mg/dL
Active Ins Time:	6 hours	2–8 hours	1 hour	—

## Sensor features default settings

Feature	Options	Default Setting	Limits, Range of Values
Sensor	<ul style="list-style-type: none"> <li>• On</li> <li>• Off</li> </ul>	Off	—

Feature	Options	Default Setting	Limits, Range of Values
Glucose Alerts	<ul style="list-style-type: none"> <li>• On</li> <li>• Off</li> </ul>	Off	Set the limits using the Glucose Limits feature.
Glucose Limits	<ul style="list-style-type: none"> <li>• Maximum of 8 Glucose Limits.</li> <li>• One pair of Glucose Limits (Glucose Limits 1) is already set up for you, with a default High Glucose Limit and Low Glucose Limit.</li> <li>• Glucose Limits 2 through 8 can be set as needed.</li> </ul>		
Glucose Limits 1	<ul style="list-style-type: none"> <li>• Low: 80 mg/dL</li> <li>• High: 240 mg/dL</li> </ul>	Low: 80 mg/dL High: 240 mg/dL	Low Glucose Limit range: <sup>a</sup> <ul style="list-style-type: none"> <li>• 40–390 mg/dL</li> </ul> High Glucose Limit range: <sup>b</sup> <ul style="list-style-type: none"> <li>• 50–400 mg/dL</li> </ul>
Glucose Limits 2 through Glucose Limits 8	<ul style="list-style-type: none"> <li>• Low: Off</li> <li>• High: Off</li> </ul>	Low Off High Off	See the Glucose Limits 1 range.
High Repeat	<ul style="list-style-type: none"> <li>• 1 Hour</li> </ul>	On 1 hour (Set to On when High Glucose, High Predictive, or Rising Rate of Change Alert is on.)	Range: 0:05–3:00 (5 minutes to 3 hours)
Low Repeat	<ul style="list-style-type: none"> <li>• 20 minutes</li> </ul>	On 20 minutes (Set to On when Threshold Suspend, Low Glucose, Low Predictive, or Falling Rate of Change Alert is on.)	Range: 0:05 – 1:00 (5 minutes to 1 hour)

Feature	Options	Default Setting	Limits, Range of Values
Predictive Alert	<ul style="list-style-type: none"> <li>• On</li> <li>• Off</li> </ul>	Off Default time sensitivity: Low 15 minutes High 15 minutes	Range: Off 0:05 – 0:30 (5 to 30 minutes)
Rate of Change Alerts	<ul style="list-style-type: none"> <li>• On</li> <li>• Off</li> </ul>	Fall Rate Limit Off Rise Rate Limit Off	Fall Rate Limit range: 1.1–5.0 mg/dL/min Rise Rate Limit range: 1.1–5.0 mg/dL/min
Threshold Suspend	<ul style="list-style-type: none"> <li>• On</li> <li>• Off</li> </ul>	Off	Range: 60–90 mg/dL
Cal Repeat	(Always on - cannot be turned off)	On 30 minutes	Range: 0:05 – 1:00 (5 minutes to 1 hour)
Cal Reminder	<ul style="list-style-type: none"> <li>• On</li> <li>• Off</li> </ul>	On 1 hour	Range: 0:05 – 6:00 (5 minutes to 6 hours)
Blood Glucose Units (BG Units)	mg/dL	mg/dL	—
Weak Signal	(Always on - cannot be turned off)	30 minutes	Range: 0:05 – 0:40 (5 to 40 minutes)
Sensor glucose graph timeout	<ul style="list-style-type: none"> <li>• 2 minutes</li> <li>• 4 minutes</li> <li>• 6 minutes</li> <li>• NONE<sup>c</sup></li> </ul>	2 minutes	—

Feature	Options	Default Setting	Limits, Range of Values
Alert Silence	<ul style="list-style-type: none"> <li>• Off</li> <li>• Hi Alerts</li> <li>• Lo Alerts</li> <li>• Hi and Lo Alerts</li> <li>• All Sensor Alerts</li> </ul>	Off	If any option other than <b>Off</b> is selected in the ALERT SILENCE screen, the SET DURATION screen displays. The value range is from 00:30 to 24:00.
AUC Limits	Always on	Low Limit 70 mg/dL  High Limit 180 mg/dL	Low Limit range: <sup>d</sup> 40–400 mg/dL  High Limit range: <sup>e</sup> 40–400 mg/dL

a. Your Low Glucose Limit must be at least 10 mg/dL below your High Glucose Limit. For example, if your High Glucose limit is 200 mg/dL, then your Low Glucose limit cannot be higher than 190 mg/dL.

b. Your High Glucose Limit must be at least 10 mg/dL above your Low Glucose Limit.

c. If you select this option the sensor glucose graphs will show continuously on the pump screen.

d. The AUC Low Limit can be equal to, but not higher than the AUC High Limit.

e. The AUC High Limit can be equal to, but not lower than the AUC Low Limit.

## Guidance and manufacturer's declaration

### Guidance and Manufacturer's Declaration - Electromagnetic Emissions

The 551/751 pump system (consisting of the MMT-551/751 pump and MMT-7703 transmitter) is intended for use in the electromagnetic environment specified below. The customer or the user of the 551/751 pump system should make sure that it is used in such an environment.

Emissions Test	Compliance	Electromagnetic Environment - Guidance
RF emissions CISPR 11	Group 1	The 551/751 pump system uses RF energy only for system communication functions. Therefore, its RF emissions are very low and are not likely to cause any interference in nearby electronic equipment.
RF emissions CISPR 11 Harmonic emissions	Class B  Not applicable	The 551/751 pump system is suitable for use in all establishments including domestic and those directly connected to the public low-voltage power supply network that supplies buildings used for domestic purposes.
IEC 61000-3-2 Voltage fluctuations/flicker emissions IEC 61000-3-3	Not applicable	 <p><b>Note:</b> The preceding statement is required by IEC 60601-1-2 for Group 1, Class B devices. However, since the 551/751 pump system is battery powered, its emissions will not be affected by the establishment power supply and there is no evidence of any issues associated with the use of the system in domestic establishments.</p>

## Guidance and Manufacturer's Declaration - Electromagnetic Immunity

The 551/751 pump system (consisting of the MMT-551/751 pump and MMT-7703 transmitter) is intended for use in the electromagnetic environment specified below. The customer or the user of the 551/751 pump system should make sure that it is used in such an environment.

Immunity Test	IEC 60601 Test Level	Compliance Level	Electromagnetic Environment - Guidance
Electrostatic discharge (ESD) IEC 61000-4-2	±6 kV contact ±8 kV air	±30 kV air (<5% relative humidity)	The 551/751 pump system should not be affected by electrostatic discharge that might occur under normal conditions of use.
Electrical fast transient/burst IEC 61000-4-4	±2 kV for power supply lines ±1 kV for input/output lines	Not applicable Not applicable	Not applicable Not applicable
Surge IEC 61000-4-5	±1 kV line(s) to line(s) ±2 kV line(s) to earth	Not applicable Not applicable	Not applicable Not applicable

## Guidance and Manufacturer's Declaration - Electromagnetic Immunity

The 551/751 pump system (consisting of the MMT-551/751 pump and MMT-7703 transmitter) is intended for use in the electromagnetic environment specified below. The customer or the user of the 551/751 pump system should make sure that it is used in such an environment.

Immunity Test	IEC 60601 Test Level	Compliance Level	Electromagnetic Environment - Guidance
Voltage dips, short interruptions and voltage variations on power supply lines IEC 61000-4-11	<5% $U_T$ (>95% dip in $U_T$ ) for 0.5 cycle	Not applicable	Not applicable
	40% $U_T$ (60% dip in $U_T$ ) for 5 cycles	Not applicable	Not applicable
	70% $U_T$ (30% dip in $U_T$ ) for 25 cycles	Not applicable	Not applicable
	<5% $U_T$ (>95% dip in $U_T$ ) for 5 seconds	Not applicable	Not applicable
Power frequency (50/60 Hz) magnetic field IEC 61000-4-8	400 A/m	400 A/m 4000 A/m	Power frequency magnetic fields should be at levels characteristic of a typical location in a typical commercial or hospital environment.



**Note:**  $U_T$  is the a.c. mains voltage prior to application of the test level.

---

## Guidance and Manufacturer's Declaration - Electromagnetic Immunity

---

The 551/751 pump is intended for use in the electromagnetic environment specified below. The customer or user of the 551/751 pump system should make sure that it is used in such an environment.

---

<b>Immunity Test</b>	<b>IEC 60601 Level</b>	<b>Compliance Level</b>	<b>Electromagnetic Environment Guidance</b>
			Portable and mobile RF communications equipment should be used no closer to any part of the 551/751 pump, including cables, than the recommended separation distance calculated from the equation applicable to the frequency of the transmitter.
			Recommended separation distance
Conducted RF IEC 61000-4-6	10 Vrms 150 kHz to 80 MHz	Not applicable	Not applicable



## Guidance and Manufacturer's Declaration - Electromagnetic Immunity

The 551/751 pump is intended for use in the electromagnetic environment specified below. The customer or user of the 551/751 pump system should make sure that it is used in such an environment.

Immunity Test	Compliance		Electromagnetic Environment Guidance
	IEC 60601 Level	Level	
Radiated RF IEC 61000-4-3	10 V/m	10 V/m and	$d = 0.35 \sqrt{P}$ 80 MHz to 800 MHz  $d = 0.70 \sqrt{P}$ 800 MHz to 6.0 GHz
	80 MHz to 2.5 GHz	200 V/m 80 MHz to 6.0 GHz	

Where  $P$  is the maximum output power rating of the transmitter in watts (W) according to the transmitter manufacturer and  $d$  is the recommended separation distance in meters (m).

Field strengths from fixed RF transmitters, as determined by an electromagnetic site survey<sup>a</sup>, should be less than the compliance level in each frequency range<sup>b</sup>.

Interference may occur in the vicinity of equipment marked with the following symbol:



---

## Guidance and Manufacturer's Declaration - Electromagnetic Immunity

---

The 551/751 pump is intended for use in the electromagnetic environment specified below. The customer or user of the 551/751 pump system should make sure that it is used in such an environment.

---

Immunity Test	Compliance	
IEC 60601 Level	Level	Electromagnetic Environment Guidance

---



**Note:** At 80 MHz and 800 MHz, the higher frequency range applies.



**Note:** These guidelines may not apply in all situations. Electromagnetic propagation is affected by absorption, and reflection from structures, objects and people.

---

<sup>a</sup>Field strengths from fixed transmitters, such as base stations for radio (cellular/cordless) telephones and land mobile radios, amateur radio, AM and FM radio broadcasts and TV broadcast cannot be predicted theoretically with accuracy. To assess the electromagnetic environment due to fixed RF transmitters, an electromagnetic site survey should be considered. If the measured field strength in the location in which the 551/751 pump is used exceeds the applicable RF compliance level above, the 551/751 pump should be observed to verify normal operation. If abnormal performance is observed, additional measures may be necessary, such as re-orienting or relocating the 551/751 pump.

<sup>b</sup>Over the frequency range 150 kHz to 80 MHz, field strengths should be less than  $[V_1]$  V/m.

---

## Recommended separation distances between portable and mobile RF communications equipment and the 551/751 pump system

This section provides information on the recommended separation distance between portable and mobile RF communications equipment and the 551/751 pump. The 551/751 pump is intended for use in an electromagnetic environment in which radiated RF disturbances are controlled. 551/751 pump users can help prevent electromagnetic interference by maintaining a minimum distance between portable and mobile RF communications equipment (transmitters) and the 551/751 pump as recommended below, according to the maximum output power of the communications equipment.

### Separation distance according to the frequency of transmitter (m)

Rated maximum output power of transmitter (W)	80MHz to 800MHz $d = 0.35 \sqrt{P}$	800MHz to 6.0GHz $d = 0.70 \sqrt{P}$
0.01	0.035	0.07
0.1	0.11	0.11
1	0.35	0.7
10	1.1	2.2
100	3.5	7

For transmitters rated at a maximum output power not listed above, the recommended separation distance  $d$  in meters (m) can be estimated using the equation applicable to the frequency of the transmitter, where  $p$  is the maximum output power rating of the transmitter in watts (W) according to the transmitter manufacturer.

---

## Recommended separation distances between portable and mobile RF communications equipment and the 551/751 pump system

---

This section provides information on the recommended separation distance between portable and mobile RF communications equipment and the 551/751 pump. The 551/751 pump is intended for use in an electromagnetic environment in which radiated RF disturbances are controlled. 551/751 pump users can help prevent electromagnetic interference by maintaining a minimum distance between portable and mobile RF communications equipment (transmitters) and the 551/751 pump as recommended below, according to the maximum output power of the communications equipment.

---

### Separation distance according to the frequency of transmitter (m)

---

<b>Rated maximum output power of transmitter (W)</b>	<b>80MHz to 800MHz</b>	<b>800MHz to 6.0GHz</b>
	<b><math>d = 0.35 \sqrt{P}</math></b>	<b><math>d = 0.70 \sqrt{P}</math></b>

---

















**Note:** At 80 MHz and 800 MHz, the separation distance for the higher frequency range applies.



**Note:** These guidelines may not apply in all situations. Electromagnetic propagation is affected by absorption and reflection from structures, objects and people.

---

## Icon table

Follow instructions for use	
Attention: Read all warnings and precautions in instructions for use.	
Manufacturer	
Date of manufacture (year - month)	
Batch code	
Use by (year - month)	
Catalogue number	
Device serial number	
Storage temperature range	
Magnetic Resonance (MR) unsafe	
Fragile product	
Type BF equipment (protection from electrical shock)	
Conforms to IEC60601-1 sub-clause 44.6 and IEC60529 standard For more information about IPX7, see the <i>Glossary</i> on page 273.	<b>IPX7</b>
Recycle	
Radio communication	











# Glossary

<b>A1C (HbA1c) test</b>	A 2-3 month average of blood glucose values expressed in percent. The normal range varies with different labs and is expressed in percent (such as 4 - 6%).
<b>Accept</b>	Pressing the <b>ACT</b> button to approve the selection or setting.
<b>Active insulin</b>	Bolus insulin that has been delivered to your body, but has not yet been used.
<b>Adverse reaction</b>	An unexpected, unpleasant or dangerous reaction to a sensor when it is inserted into the body. An adverse reaction may be sudden or may develop over time.
<b>Alarm</b>	Audible or vibrating (silent) notice that indicates the pump is in Attention mode and immediate attention is required. Alarms are prefixed in the alarm history with the letter A.
<b>Alarm clock</b>	Feature you can set to go off at specified times of the day.
<b>ALARM HISTORY</b>	Screen that displays the last 36 alarms/errors that have occurred on your pump.
<b>Alarm icon</b>	a solid circle that shows at the top of the screen and the pump beeps or vibrates periodically until the condition is cleared (see Attention mode).
<b>Alert</b>	Audible or vibrating (silent) indicator that notifies you the pump needs attention soon or that you should be

reminded of something. Insulin delivery continues as programmed.

---

<b>Alert icon</b>	an open circle that appears at the top of the screen and the pump beeps or vibrates periodically to remind you of the condition (see Special mode).
<b>Attention mode</b>	Operating mode that stops all current insulin delivery. This mode indicates an alarm or condition exists that requires immediate attention.
<b>AUC Limits</b>	The AUC Limits feature allows you to see how long your sensor glucose measurements are outside your target range. Your target range is the area between your Low AUC Limit and your High AUC Limit. When you set the AUC Limits, you select the Low AUC Limit and High AUC Limit you want for your target range.
<b>Backlight</b>	Pump screen light. Turns on whenever the  button is pressed or in combination with the  button if not on the HOME screen. The backlight also appears during alarms and alerts, except for LOW BATTERY alert and OFF NO POWER alarm.
<b>Basal patterns</b>	The user can program up to three different basal rate patterns into the pump for the delivery of basal insulin: Standard, A, and B. For each pattern, there is an option of setting up to 48 basal rates.
<b>Basal rate</b>	The pump setting that provides a continuous infusion of insulin to keep the blood glucose stable between meals and during the night. Basal insulin mimics pancreatic insulin delivery—which meets all the body's non-food related insulin needs.
<b>BASAL REVIEW screen</b>	shows the basal rates programmed in the pump, with the 24-hour total for each rate.
<b>BG</b>	Blood Glucose
<b>BG Reminder</b>	Feature that you can set to remind you to check your blood glucose after a bolus.
<b>BG Target</b>	Normal blood glucose level

---

<b>BG Units</b>	Blood glucose units used by the pump (mg/dL).
<b>Block</b>	Feature that restricts access to all programming except manual Suspend, Selftest and the delivery of a bolus with the remote control.
<b>Blood glucose (BG)</b>	A form of digested sugar in the bloodstream. Glucose is the major source of energy for living cells, and is carried to each cell through the blood stream. Cells cannot use glucose without the help of insulin.
<b>Bolus</b>	A dose of insulin given to cover an expected rise in blood glucose (such as the rise after a meal) or to lower a high blood glucose down to target range.
<b>BOLUS HISTORY</b>	This screen displays the last 24 boluses delivered by your pump.
<b>Bolus Wizard® feature</b>	Calculates the bolus amount based on personal information of the pump user.
<b>Cal Reminder</b>	The value of the Cal Reminder is the amount of time before the current calibration value expires when the user wants to be reminded to calibrate by having the pump issue a METER BG BY alert. For example, if the Cal Reminder is set to two hours, the METER BG BY alert will occur two hours before the calibration is required.
<b>Cal Repeat</b>	Once a METER BG NOW alert occurs, the pump will not repeat the alert until after this selected Cal Repeat time.
<b>Calibrate</b>	Check, adjust, or set to a standard (calibrate your pump).
<b>Cannula</b>	A short, thin, and flexible tubing at the end of the infusion set that is inserted into the subcutaneous tissue to deliver insulin.
<b>Carb ratio (Carbohydrate ratio)</b>	Used when counting carbohydrates in grams. The amount of carbohydrates covered by one unit of insulin. (Also see exch ratio.)
<b>Carb units</b>	The food entry when using the Bolus Wizard feature. Entered as (carbohydrate) grams or exchanges.
<b>Carbohydrate</b>	One of the three main sources of energy or calories in food. Carbohydrates are mainly sugars found in fruits,

milk, and starches that the body breaks down into glucose.

<b>CH</b>	Carbohydrate
<b>Contraindication</b>	A condition that makes a specific treatment or procedure NOT advisable. A contraindication is literally contra- (against) an indication, against something that is indicated as advisable or necessary.
<b>Correction bolus</b>	The amount of insulin needed to return a high blood glucose level back down to target range.
<b>Daily totals</b>	Shows the total insulin delivered (basal and bolus) in the last 24-hours. Maximum records: 32 days
<b>Default</b>	A setting or value for your pump that is assigned automatically by your system. Some default settings cannot be changed; other default settings remain in effect until you change them.
<b>Diabetic Ketoacidosis (DKA)</b>	A serious condition that occurs when the insulin levels are low, blood glucose level are elevated, and the body uses fat for energy. This process produces ketones which upset the body's acid-base balance leading to a potentially life threatening situation.
<b>DKA</b>	Diabetic Ketoacidosis
<b>Dual Wave® bolus</b>	Combination of a Normal bolus that is delivered immediately, then followed by a Square Wave bolus. The Square Wave portion is delivered evenly over a period of time.
<b>Duration</b>	Amount of time it takes to administer a bolus or basal delivery. Also, length of time for an action or condition.
<b>Easy bolus™</b>	Method of delivery for a Normal bolus using the Easy Bolus button  .
<b>Electromagnetic compatibility</b>	The condition that exists when systems and devices that use electromagnetic energy operate properly without causing or suffering accidental electromagnetic interference to or from other electromagnetic devices.

<b>Electrostatic discharge</b>	The rapid, spontaneous transfer of electrostatic charge induced by a high electrostatic field. The charge usually flows through a spark, known as static discharge, between two objects at different electrostatic levels as they approach each other (for example, when people touch each other after dragging their feet on a carpet).
<b>Exch ratio</b>	(Exchange ratio) Used when counting carbohydrates as exchanges. The amount of insulin required to cover one (1) carbohydrate exchange. (Also see carb ratio.)
<b>Express bolus</b>	Method of delivery for any bolus type using the <b>EXPRESS BOLUS</b> button  .
<b>Fingerstick</b>	One method used to test blood glucose by taking a sample of blood for testing from a finger using a lancet or automatic finger puncture device.
<b>Food bolus</b>	A dose of insulin given to cover the expected rise in blood glucose that occurs after eating.
<b>Gastroparesis</b>	A condition of the digestive system that slows down the emptying of food from the stomach.
<b>Generate</b>	create a result (your pump will generate a graph).
<b>Glucagon Emergency Kit</b>	An injectable form of glucagon that can be used to treat severe low blood glucose levels (hypoglycemia). A Glucagon Emergency Kit can be obtained in a pharmacy with a prescription.
<b>Glucose tablet</b>	A simple sugar in tablet form, that is taken orally to treat low blood glucose (hypoglycemia). Glucose tablets can be purchased from the Medtronic Diabetes online store at <a href="http://www.medtronicdiabetes.com">www.medtronicdiabetes.com</a> as well as drug stores and pharmacies.
<b>HbA1c</b>	Glycosylated hemoglobin.
<b>HDL</b>	High-density lipoprotein A complex of lipids and proteins in approximately equal amounts that functions as a transporter of cholesterol in the blood.

<b>High Glucose</b>	The pump displays an alert if the sensor indicates that your sensor glucose is at or above this value. You have the option to turn this feature on or off.
<b>High Repeat</b>	For the High Glucose, High Predictive, and Rising Rate of Change alerts, allows the user to set the delay between the first alert and any subsequent alerts. This will allow the user to avoid getting an alert every five minutes until the condition is corrected.
<b>Hold</b>	Press and continue to press a pump button.
<b>Hyperglycemia</b>	A condition in which blood glucose values are elevated above target. Symptoms may include excessive thirst, frequent urination, dry mouth, headache, fatigue, and blurred vision.
<b>Hypoglycemia</b>	A condition in which blood glucose values are below 70 mg/dL. Symptoms may include behavioral changes, pale complexion, hunger, sweating, sudden weakness, headache, confusion, drowsiness, non-responsiveness to questions, and the most serious: seizure, convulsion or loss of consciousness.
<b>Idle</b>	The pump is at the HOME screen.
<b>Increment</b>	A small increase or decrease in a measurement.
<b>Indication</b>	A condition that makes a specific medical treatment or procedure advisable or necessary.
<b>Infusion set</b>	Flexible tubing with a reservoir connector and an infusion site. This tubing delivers insulin from the pump to the body.
<b>Infusion site</b>	The end of the infusion set held to the body with a tape. It consists of a cannula and an introducer needle.
<b>Initialize</b>	To set a starting value or prepare your pump, transmitter or sensor for use.
<b>Insulin</b>	A hormone that helps the body use glucose (sugar) for energy. The beta cells of the pancreas make the insulin.

<b>Insulin sensitivity</b>	The amount by which your blood glucose (BG) level is reduced by one unit of insulin. (Bolus Wizard feature data)
<b>Insulin to carbohydrate ratio</b>	The amount of insulin required to cover a given number of carbohydrates. This ratio helps you estimate what size bolus you should take when eating carbohydrates. Your healthcare professional will determine your insulin to carbohydrate ratio.
<b>Interstitial fluid</b>	The fluid between the cells in the human body.
<b>Introducer needle</b>	This needle allows the insertion of a cannula or a sensor into the subcutaneous tissue. It is removed and discarded after insertion leaving only the cannula or the sensor in the body.
<b>IPX7</b>	Protected against water immersion. Immersion for 30 minutes at a depth of up to 1 meter.
<b>Ketone</b>	A chemical created by the human body when there is not enough insulin in the blood.
<b>kPa (kilopascal)</b>	A unit of measurement for quantifying force. Used to measure atmospheric pressure. Equivalent to 10,000 dynes per square centimeter.
<b>LDL (Low-density lipoprotein)</b>	A complex of lipids and proteins, with greater amounts of lipid than protein, that transports cholesterol in the blood.
<b>Link</b>	To turn on and setup the meter option that allows the pump to receive BG readings from a meter that communicates with your pump.
<b>Log</b>	A record of measurements, alarms or other actions by your pump.
<b>Low Glucose</b>	The pump displays an alert if the sensor indicates that your sensor glucose is at or below this value. You have the option to turn this feature on or off.
<b>Low Repeat</b>	For the Low Glucose, Low Predictive, and Falling Rate of Change alerts, as well as the Threshold Suspend alarm, you can set the delay between the first alert and any

subsequent alerts. This will allow the user to avoid getting an alert every five minutes until the condition is corrected. However, this could cause your pump to suspend again. For more information, see *About Threshold Suspend* in the *Sensor features* chapter.

---

**Low resv warning**

Programmable warning that notifies you with an alert when either a specified number of units remain in the reservoir or a specified amount of time remains before the reservoir will be empty.

---

**Manual bolus**

Selectable item available in the BOLUS MENU when the Bolus Wizard feature is active. It is one method of programming a bolus without the Bolus Wizard feature. (see *Set bolus*)

---

**Manual Suspend**

Function that stops all current insulin deliveries. The basal delivery is paused until you manually restart the basal insulin delivery.

---

**Marker**

A measurement of a specific event - such as a BG measurements, exercise, or the amount of insulin used.

---

**Max basal rate**

The maximum amount of basal insulin that the pump will deliver at one time. (set by the user)

---

**Max bolus**

The maximum amount of bolus insulin that the pump will deliver at one time. (set by the user)

---

**Meter**

An optional blood glucose meter powered by MWT1 technology. Your pump can be programmed to receive your BG readings from this meter.

---

**Meter option**

Feature that allows the pump to receive BG readings from a meter powered by MWT1 technology.

---

**MWT1 technology**

MWT1 is the wireless Radio Frequency (RF) technology that is used to transmit information from the meter to the pump. You can program your pump to automatically receive your BG reading from this meter.

---

**Normal bolus**

An immediate delivery of a specified unit amount of insulin.

---



<b>Normal mode</b>	Regular operating mode. No special features are active, no alert or alarm conditions exist. Insulin delivery is normal during this mode.
<b>Now portion</b>	The normal portion of a Dual Wave bolus. The now portion delivers immediately and is then followed by the Square portion.
<b>Occlusive dressing</b>	A bandage that seals a wound from air or bacteria.
<b>Pattern A/B</b>	Basal pattern that supports activities that are not a part of your day-to-day routine, but are normal in your lifestyle. Such activities could be a sport that you do once a week or a change in your sleep pattern over the weekend, extended periods of higher or lower activity, or menses.
<b>Predictive alerts</b>	These alerts can be used so that you receive alarms before the sensor glucose measurements reach your glucose limits. This alert predicts when the sensor glucose measurements will reach your glucose limits by using information about your glucose limits and recent sensor glucose measurements.
<b>Press</b>	To push and release a button.
<b>PSI</b>	Pound-force per square inch.
<b>Pump S/N</b>	Pump S/N is the serial number of the pump currently in use.
<b>Rate of Change alerts</b>	These alerts can be used to set up the system so that you receive alerts if the sensor glucose measurements change too rapidly for your needs. You can set the limit for these alerts so that you receive an alert whenever the sensor glucose measurements fall or rise faster than the limit.
<b>Reservoir</b>	The syringe that holds insulin.
<b>Reset</b>	To set again, or change the information (reset your glucose values).
<b>Resume</b>	Restarts basal delivery after the pump is manually suspended.

<b>Rewind</b>	The pump drive moves back to its starting position to prepare the pump for a new reservoir.
<b>RF</b>	Radio frequency
<b>Scroll</b>	Press the up or down arrow buttons to move through the screen text.
<b>Select</b>	Pressing the up or down arrow buttons to highlight a desired screen item.
<b>Sensitive</b>	Easily irritated (sensitive skin), or able to measure very slight differences (a sensitive instrument).
<b>Sensor Age</b>	Sensor age is the amount of time, in days and hours, since the sensor was first inserted.
<b>Sensor features</b>	Optional continuous glucose monitoring capabilities.
<b>sensor (glucose sensor)</b>	The small part of the continuous glucose monitoring system that you insert just below your skin to measure glucose levels in your interstitial fluid.
<b>Sensor glucose (SG)</b>	Glucose levels in the fluid under your skin measured by the sensor.
<b>Sensor icon</b>	An icon on your pump that tells you whether the Sensor feature is On or Off.
<b>Serter</b>	The Serter is an aid for the insertion of a Medtronic Diabetes glucose sensor.
<b>Set</b>	To enter or establish a value for your pump (set your BG Reminder).
<b>Set bolus</b>	Selectable item available in the BOLUS MENU when the Bolus Wizard feature is inactive. One method of programming a bolus without the Bolus Wizard feature. (See <i>Manual bolus</i> .)
<b>S/N#</b>	Serial number.
<b>Special mode</b>	Operating mode that indicates one or more special functions is active or a condition exists that requires attention.
<b>Square Wave® bolus</b>	Immediate bolus delivered evenly over a specified time period (30 minutes to 8 hours).

<b>Square Wave portion</b>	(Sq) The second part of a Dual Wave bolus. The Square Wave portion delivers evenly over a period of time after the NOW portion delivers.
<b>Stabilize</b>	To make steady or keep from changing (stabilize your blood glucose).
<b>Standard pattern</b>	Your normal basal that supports your usual day-to-day activity. When the Patterns feature is off, the pump uses your standard basal pattern.
<b>Status</b>	The condition of a part of your system (battery status, alarm/alert status).
<b>Status screen</b>	Displays the current operations of the pump, including active functions, the most recent basal and bolus deliveries, reservoir information, and battery condition.
<b>Step</b>	Measurement of insulin that you set and use for Easy Bolus and other bolus deliveries.
<b>Sterile</b>	Free from substances or germs that could cause infection.
<b>Sterile gauze</b>	A thin medical bandage with loose weave that is free from substances or germs that could cause infection.
<b>Submerge</b>	To place under water or cover completely with water.
<b>Temp</b>	Temporary.
<b>Temp basal</b>	(Tmp basal) Temporary one-time basal insulin with a specified amount and duration. Used to support insulin needs for special activities or conditions that are not part of the normal daily routine.
<b>Threshold Suspend</b>	This feature is set up to stop insulin delivery when your sensor glucose reaches or drops below your Suspend Threshold. Insulin delivery will automatically restart after 2 hours if you do not restart insulin delivery yourself sooner.
<b>Timeout</b>	If you do not enter information or do something in a specific length of time, your pump automatically stops what it is doing and goes to the HOME screen.

---

<b>Transmitter</b>	The device that sends a signal to your pump with information from your sensor.
<b>Transmtr Batt</b>	The status of the transmitter battery. Possible values are <b>Good</b> , <b>Low</b> , or <b>Bad</b> .
<b>Transmtr ID</b>	The serial number of the transmitter currently in use.
<b>Transmtr Ver</b>	The software version of the transmitter currently in use.
<b>Weak Signal</b>	The pump displays an alert if it has not received data from the sensor for an amount of time that you set.

---





# Index

## Numerics

- 3-hour graph 156
- 6-hour graph 156
- 12-hour graph 157
- 24-hour graph 157

## A

### accessories

- activity guard 6
- CareLink USB 6
- holster 6
- leather case 7
- meter 6
- pump clip 6
- remote control 6
- sensor 6
- transmitter 6
- active insulin 90
- Active insulin time
  - setting 90
- alarm clock 175
- alarm frequency 239
- ALARM HISTORY screen 165
- Alarm types
  - A (alarm) 203
  - Auto off 204
  - Batt out limit 204
  - Bolus stopped 204
  - Button error 204
  - Check settings 205, 224
  - E (error) 205
  - Empty reservoir 205

- Failed batt test 206
- Finish loading 206
- Max delivery 206
- Max fill reached 206
- Motor error 206
- No delivery 207, 223
- No reservoir 207
- Off No power 208
- Reset 208
- table 203
- Thresh Suspend (Threshold Suspend) 208
- Weak battery 212
- Alarms 202
  - about 201
  - review 165
- alert frequency 239
- Alert Silence 159
  - default settings 260
  - options 160
- Alert Silence alert 214
- alert type
  - Setting your 165
- alerts 214
  - Alert Silence 214
  - Cal Error 214, 215
  - Change Sensor 215
  - Charge Transmtr 215
  - Fall Rate 215
  - for alert conditions 213
    - low reservoir alert 213
  - High Predicted 216
  - High XXX MG/DL 216

- Lost Sensor 216
- Low Predicted 217
- Low Transmtr 217
- Low XX MG/DL 218
- Meter BG By 218
- Meter BG Now 218
- Missed Bolus 214
- Rise Rate 219
- Sensor End 219
- Sensor Error 219
- Weak Signal 219
- Alerts
  - about 201
- Area Under the Curve 173
- areas
  - inserting infusion set 73
- Attention mode 30
- AUC calculation 173
- AUC Limits 173, 174
  - default settings 260
  - entering 174
- auto-off 166
- B**
- backlight 29, 274
- BASAL MENU 32
- basal rate
  - daily 57
  - maximum 58
  - patterns 110
  - programming 56
  - stop delivery of 59
  - temp 113
- Basic programming 37
- bathing 161
- battery, pump 235, 245
  - insert 23
  - removing 224
  - short life 225
- beep/vibrate, alert type 29
- BG, entering 50
- BG Reminder 41, 48, 93, 101, 105
- BG Targets 88
- BG units
  - default settings 259
- Block feature 178
  - turn on 178
- BLOCK OPTION screen 178
- blood glucose
  - checking 145
  - entering incorrect number 214
  - rapid change 214
- blood glucose measurements 50, 138
  - non-calibration meter, examples of 50
- blood glucose units
  - default settings 259
  - setting 130
- bolus
  - basic 40
  - details 45
  - history 44
  - manual 101
  - maximum limit 46
  - stop delivery of 59
- bolus delivery
  - Bolus Wizard 91
  - Easy Bolus 105
- bolus delivery, methods for normal
  - remote control 6
- BOLUS MENU 32
- bolus types
  - Dual Wave 100
  - Normal 40
  - Square Wave 99
- Bolus Wizard
  - about 81
  - entering meter BG 146
  - estimate details 45
  - HIGH BG warning 84
  - how it works 84
  - LOW BG warning 84
  - MAX BOLUS EXCEEDED warning 84
  - maximum delivery 84
  - on/off 85
  - review settings 91



- settings 81, 82, 83
  - Active insulin time 83
  - BG Target range 83
  - Carb ratios 82
  - Carb units 82
  - Insulin sensitivity 83
- specifications 250
- using 81
- your BG reading 81

buttons, pump 21, 25

## C

Cal Error alert 214, 215

Cal Reminder 218

- default settings 259
- setting 138

CAL REMINDER screen 138

Cal Repeat

- default settings 259
- setting 138

CALIBRATE HISTORY 161

calibrating

- frequency 145

calibrating sensor 145

- frequency 145

calibrating your system

- Capture Event feature 49

calibration

- successful 160
- values 160

Calibration history 160, 161

CAPTURE EVENT 32

Capturing Events 49

Carb ratios

- exchanges 86
- grams 86

carb units 86

CARB UNITS screen 52

CareLink Personal Software 49, 53

CareLink software 193

CareLink USB 6

Change Sensor alert 215

Charge Transmtr alert 215

charger 6

CHECK BG message 48

checking

- blood glucose 145

cleaning

- Serter 236
- transmitter 236

cleaning the pump 236

Clear settings 181

connecting transmitter to

- sensor 142
- tester 229

continuous glucose graphs

- reading 151

continuous graph display 140

continuous sensor glucose levels 154

correction bolus 40, 91, 92

correction estimate 146, 250

## D

Daily totals 168

DAILY TOTALS screen

- Review 167

default settings

- Alert Silence 260
- AUC Limits 260
- BG Units 259
- Cal Reminder 259
- Cal Repeat 259
- Glucose Alerts 258
- Glucose Limits 258
- Glucose Limits 1 258
- Glucose Limits 2 through 8 258
- High Glucose Limit 258
- High Repeat 258
- insulin delivery 255
- Low Glucose Limit 258
- Low Repeat 258
- Predictive Alerts 259
- sensor 257
- sensor features 257
- sensor glucose graph timeout 259
- Weak Signal 259

DELIVERY STATS screen 171, 172  
disconnecting  
    tester from transmitter 230  
Dual Wave bolus programming  
    with Bolus Wizard 103  
    without Bolus Wizard 100  
dual/square option  
    on-off 100

## E

Easy bolus 105  
    cancel 107  
    deliver 106  
    step value 106  
electromagnetic emissions 261  
Electromagnetic environment 267  
electromagnetic immunity 262  
emergency kit 4  
emissions 261  
ENTER BG screen 50  
ENTER FOOD screen 52  
entering  
    carbohydrate information 52  
    exercise information 53  
    manual insulin injection information 51  
    meter BG 50, 145, 146, 147  
        alert 145  
        Bolus Wizard 146  
        frequency 145  
    Other markers 53  
ESC 7  
    cancels programming 33  
Examples of continuous sensor glucose  
    graphs 155  
exercising  
    precaution 15  
EXPRESS BOLUS button 26

## F

Fall Rate alert 215  
Fall Rate of Change  
    setting alert frequency 133  
FILL TUBING screen 72

filling  
    cannula 76  
    reservoir 66  
    tubing 71  
FIND LOST SENSOR 230  
food bolus 40, 82, 84, 91, 92  
food entry 81, 92  
food estimate 250, 251  
frequency  
    alarm 239  
    alert 239

## G

Glucose Alerts  
    default settings 258  
    turning on 130  
GLUCOSE ALERTS screen 130  
Glucose Limits  
    default settings 258  
Glucose Limits 1  
    default settings 258  
Glucose Limits 2 through 8  
    default settings 258  
glucose monitoring settings  
    entering 130, 131, 134, 135, 138, 174  
    setting AUC limits 174  
    setting Glucose Limits 130  
    setting Glucose Limits,  
        guidelines 131  
    setting Glucose Limits, setting  
        start time 131  
    setting Glucose Limits, switching  
        limits off 131  
    setting Predictive glucose alert 134  
    setting Rate of Change alerts 135  
    setting the Cal Reminder 138  
    turning on Glucose Alerts 130  
graphs 154  
    continuous glucose 151  
    continuous sensor glucose levels 154  
    differentiating between current and  
        earlier events in 154  
    opening 154

green light  
transmitter 229

## H

high BG levels  
Bolus Wizard and 84  
HIGH BG warning 84  
High Glucose Limit  
alert 216  
default settings 258  
setting 131  
High Predicted alert 216  
High Predictive alert 135  
High Repeat  
default settings 258  
setting 132  
High Repeat alert  
setting 133  
High sensor glucose alert 216  
history  
alarms 165  
bolus delivery 44  
calibration 160, 161  
delivered insulin 76  
sensor alert 161  
user settings 182  
HOME screen 27

## I

infusion set 5, 66  
changing your 69  
inserting 73, 74  
best sites 74  
rotating sites 74  
initialization 144  
insulin delivery  
stopped 136, 137  
Insulin pump therapy follow-up 197  
Insulin sensitivity 87  
Introduction 3  
ISIG 229

## L

Language setting 39  
list  
calibration values 160  
sensor alert 161  
Lock keypad feature 179  
Lost Sensor alert 216  
low battery  
affects selftest 179  
affects your alert type 165  
low BG levels  
Bolus Wizard and 84  
LOW BG warning 84  
Low Glucose  
setting alert frequency 133  
Low Glucose Limit  
default settings 258  
setting 131, 218  
Low Predicted alert 217  
Low Predictive  
setting alert frequency 133  
Low Repeat  
default settings 258  
setting 133  
low reservoir alert 213  
Low resv warning feature 166  
Low sensor glucose alert 218  
low transmitter battery 217  
Low Transmtr alert 217

## M

MAIN MENU 31  
Maintenance 235  
manual Suspend function 32, 59  
Max basal rate 58  
MAX BOLUS EXCEEDED warning 84  
Maximum bolus limit 46  
menus 31  
meter 6, 81  
entering BG 145, 147  
Meter BG By alert 218  
METER BG NOW alert 138  
Meter BG Now alert 218

- meter IDs
  - add, delete, review 188
- Meter option 187
- meter option
  - rules 188
- METER OPTION screen 189
- METER STATS screen 171, 172
- MiniLink transmitter 6
- Missed Bolus alert 214
- Missed Bolus Reminder 108
- modes
  - Attention 30
  - Normal 30
  - Special 30
- MWT1 6
- MWT1 technology 81, 147

## N

- no delivery 223
- Normal bolus
  - with Bolus Wizard 91
  - without Bolus Wizard 40
- Normal mode 30
- Now 104
- Now portion
  - of the Dual Wave bolus 101, 104

## O

- Optimizing pump therapy 99
- Other markers 53

## P

- Patterns
  - basal 110
  - on/off 110
  - pattern A, B 110
  - Program a basal pattern 110
  - Select a basal pattern 111
  - standard basal pattern 110
- Personal reminders 175
- personal settings 81
- practicing with your pump 22

- precaution
  - sensor 15
- Predictive Alerts 259
- PREDICTIVE ALERTS LOW/HIGH screen 134
- programming sensor 129
- pump
  - battery compartment 21
  - buttons 21, 25
  - if you remove your 34
  - practicing 22
  - screen 21, 26
  - using in water 227
  - warranty v
- Pump specifications 239

## Q

- Quick-set infusion set
  - disconnecting 77
  - reconnecting 77

## R

- Rate of Change alerts
  - sensitivity and alarm frequency 135
- reading the continuous glucose graphs 151
- RECONNECT OLD SENSOR 230
- Reminder, alarm clock 175
- remote control 6
- remote control IDs
  - add, delete, review 177
- Remote control option
  - turn on 176
- removing your pump 34
- reservoir
  - filling the 66
  - inserting in your pump 70
  - low reservoir warning 166
  - plunger rod 67
  - removing the 69
  - transfer guard 67
  - tubing connector 21
- RESERVOIR + SET 33
- reservoirs 5
- Restore settings 181

- REVIEW SETTINGS screen 141
- reviewing
  - sensor settings 141
- rewinding your pump 70
- RF communications 267
- RF features
  - remote control 176
- Rise Rate alert 219

## S

- Save settings 180
- screens
  - DELIVERY STATS 171, 172
  - METER STATS 171, 172
  - SENSOR STATS 171, 172
- scroll bar 29
- Scroll rate
  - setting 47
- Selftest 179, 227
- sensor
  - alerts 161, 214
    - history 161
    - list 161
  - calibrating 145, 218
  - connecting with transmitter 142
  - default settings 257
  - disconnected 217
  - information 151
  - ISIG 229
  - life 219
  - precaution 15
  - programming 129
  - reconnecting 230
  - setting up 129
  - signals 219
    - too high 219
    - too low 219
  - stabilizing 214
  - starting 124
  - status screens 151
  - Transmitter ID 139
  - using in water 161
- SENSOR ALERT HISTORY 161

- sensor alerts
  - Alert Silence 214
  - Cal Error 214, 215
  - Change Sensor 215
  - Charge Transmtr 215
  - Fall Rate 215
  - High Predicted 216
  - High XXX MG/DL 216
  - Lost Sensor 216
  - Low Predicted 217
  - Low Transmtr 217
  - Low XX MG/DL 218
  - Meter BG By 218
  - Meter BG Now 218
  - Missed Bolus 214
  - Rise Rate 219
  - Sensor End 219
  - Sensor Error 219
  - Weak signal 219
- Sensor Demo 141
- SENSOR DEMO ON/OFF screen 141
- Sensor End alert 219
- Sensor Error alert 219
- Sensor features 123
- Sensor function 32
- sensor glucose graph timeout 140
  - default settings 259
- sensor glucose graphs
  - continuous display 140
- sensor glucose levels
  - graphs 154
- sensor graph
  - example 141
- SENSOR ON/OFF screen 130
- SENSOR STATS screen 171, 172
- SENSOR STATUS 151
- Serter
  - cleaning 236
- SET AUC LIMITS screen 174
- SET CAL REMINDER screen 138
- SET CAL REPEAT screen 138
- SET FALL RATE LIMIT screen 136
- SET GLUCOSE LIMITS 1 screen 131
- SET GRAPH TIMEOUT screen 140

- SET HI ALERT REPEAT screen 133
- SET LO ALERT REPEAT screen 133
- SET RISE RATE LIMIT screen 136
- SET TIME SENSITIVITY LOW/HIGH screen 134
- SET TRANSMITTER ID screen 139
- SET WEAK SIGNAL screen 140
- setting
  - Cal Reminder 138
  - Cal Repeat 138
  - High Repeat 132
  - Low Repeat 133
  - sensor glucose graph timeout 140
  - Threshold Suspend 136, 137
- setting up sensor 129
- settings
  - entering 130, 131, 134, 135, 138, 174
    - glucose monitoring settings,
      - setting AUC limits 174
    - glucose monitoring settings,
      - setting Glucose Limits,
        - guidelines 131
    - glucose monitoring settings,
      - setting Glucose Limits, setting
        - start time 131
    - glucose monitoring settings,
      - setting Predictive glucose
        - alert 134
    - glucose monitoring settings,
      - setting Rate of Change alerts 135
    - glucose monitoring settings,
      - setting the Cal Reminder 138
    - glucose monitoring settings,
      - turning on Glucose Alerts 130
  - glucose
    - monitoring 130, 131, 134, 135,
      - 138, 174
    - setting AUC limits 174
    - setting Glucose Limits 130
    - setting Glucose Limits,
      - guidelines 131
    - setting Glucose Limits, setting
      - start time 131
    - setting Predictive glucose alert 134
    - setting Rate of Change alerts 135
    - setting the Cal Reminder 138
    - turning on Glucose Alerts 130
    - sensor glucose graph timeout 140
    - troubleshooting 223
  - settings, reviewing 141
  - showering 161
  - silent alerts 159
  - Special mode 30
  - Square portion
    - of the Dual Wave bolus 104
  - Square Wave bolus programming
    - with Bolus Wizard 103
    - without Bolus Wizard 100
  - Starting on insulin 65
  - starting sensor
    - steps before 124
  - STATUS screen 33
  - Step value setup 106
  - supplies, ordering 6
  - swimming 161
  - system initialization 144

**T**

  - Temp basal
    - canceling 118
    - delivering 116
    - rates 113
    - selecting type 116
    - verify delivery 117
  - temp basal types
    - Insulin rate 114
    - Percent of basal 114
  - terms and symbols 7
  - test plug. See tester 229
  - tester 6
    - connecting to transmitter 229
    - disconnecting from transmitter 230
  - The basics 21
  - therapy follow-up
    - Recommended 197
  - Therapy management software 193
  - THRESH SUSPEND 208

- Threshold Suspend
  - about 136
  - setting 137
- time and date, setting 37
- transmitter
  - cleaning 236
  - connecting with sensor 142
  - depleted battery 215
  - disconnected 217
  - green light 229
  - low battery 217
  - tester 6
  - using in water 161
  - warning 14
- Transmitter ID
  - setting 139
- Troubleshooting 223, 230
- tubing
  - filling 71

## U

- uploading pump data 6
- User settings 180
- User Settings screen 228
- Using the Bolus Wizard feature 81
- using the Capture Event feature 49
- Using your sensor 151
- Utilities 165
- UTILITIES MENU 33

## V

- viewing
  - calibration values 160, 161
  - sensor alert history 161

## W

- warnings
  - transmitter 14
- warranty v
- water, using your system in 161
- water-tightness 161

- Weak Signal 219
  - default settings 259
- Weak Signal alert 219
- Weak Signal feature 140
  - description 139

