

MiniMed™ 780G system

Changing the Medtronic Extended Infusion Set with Extended Reservoir



Table of Contents

Changing the Medtronic Extended Infusion Set with Extended Reservoir.....2

The Extended infusion set and Extended reservoir can be used for up to seven days. In most cases, the infusion set and reservoir should be changed at the same time.

Disconnecting and Reconnecting the Medtronic Extended Infusion Set with Extended Reservoir..... 10

Changing the Medtronic Extended Reservoir Only..... 11

The Extended reservoir can be used for up to seven days. If the reservoir runs out of insulin and the infusion set has not been used for seven full days, the New Reservoir Only option may be used to change the reservoir. The infusion set must still be replaced within seven days of use.

Changing the Medtronic Extended Infusion Set Only..... 18

The Extended infusion set can be used for up to seven days. If only the infusion set needs to be changed before seven full days of use, the New Set Only option may be used to change the infusion set. The reservoir must still be replaced within seven days of use.

Inserting the Guardian™ 4 Sensor with One-press Serter..... 25

WARNING: The following warning applies to changing the reservoir and infusion set, changing the reservoir only, and changing the infusion set only.

Always confirm that the infusion set tubing is disconnected from the body before doing the following steps:

- placing the reservoir into the pump
- rewinding the pump
- loading the reservoir
- filling the infusion set tubing

Failing to disconnect the infusion set tubing from the body may result in an accidental infusion of insulin, and may cause hypoglycemia.



Changing the Medtronic Extended Infusion Set with Extended Reservoir



The Extended infusion set and Extended reservoir can be used for up to seven days. In most cases, the infusion set and reservoir should be changed at the same time.



Changing the Medtronic Extended Infusion Set with Extended Reservoir

Follow these steps to change the infusion set and reservoir.



1 Wash hands with soap and water. On the pump, press to go to the menu screen.



2 Select , and then select **New Reservoir & Set**.

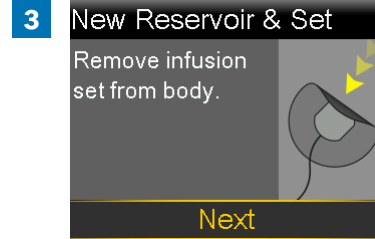

3 Remove the infusion set by loosening the adhesive and pulling the set away from the body. Select **Next**.

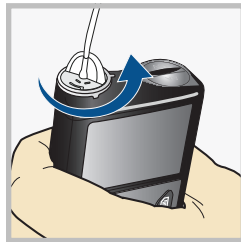

4 Remove the used reservoir from the pump.



5 Select **Rewind**.
Do not connect the infusion set to the body.

WARNING: Always confirm that the infusion set is disconnected from the body before rewinding the pump. Failing to disconnect the infusion set from the body may result in an accidental infusion of insulin, and may cause hypoglycemia.

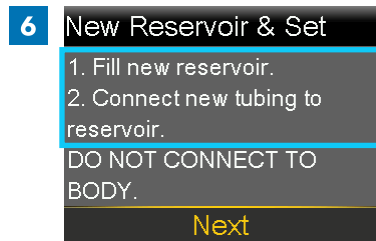

6 Follow the next steps to fill the new reservoir with insulin and to connect the new infusion set tubing. Do not select **Next**.



Changing the Medtronic Extended Infusion Set with Extended Reservoir

Fill the reservoir

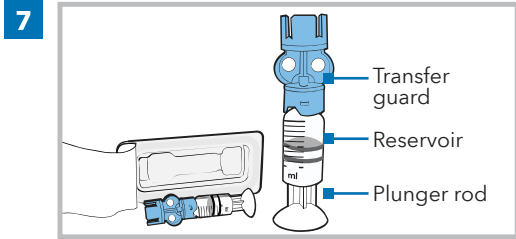

Remove the reservoir from the package. Make sure the insulin vial is at room temperature to reduce the risk of air bubbles.

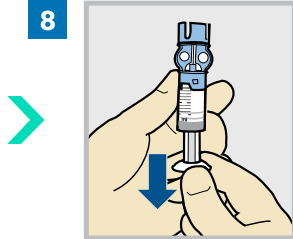

Pull the plunger down to the amount of insulin needed.

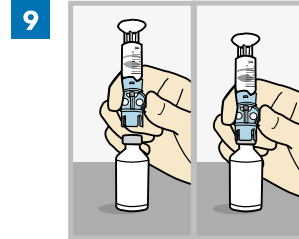

Wipe the top of the vial with isopropyl alcohol. Place the vial on a sturdy, flat surface. Firmly press the transfer guard onto the vial.

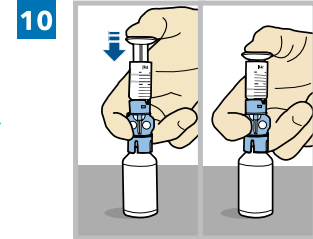

Push and hold the plunger down.

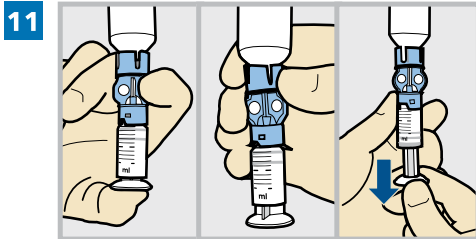

Keeping a thumb on the plunger, flip the vial over so the vial is on top. Release the thumb and pull the plunger down to fill the reservoir with insulin.

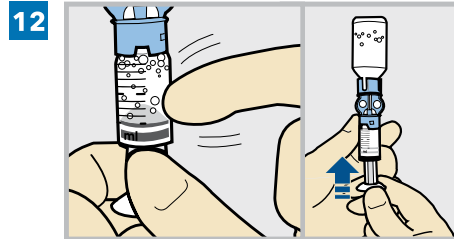

Tap the reservoir to move air bubbles to the top of the reservoir. Push the plunger up to move air into the vial.

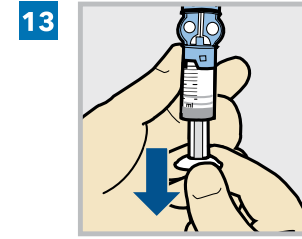

Pull the plunger back down to allow the reservoir to fill with the amount of insulin needed.

Note: The Extended infusion set and Extended reservoir can be used for up to seven days. To avoid wasting insulin, fill the reservoir with enough insulin to last until the next infusion set change.



Changing the Medtronic Extended Infusion Set with Extended Reservoir

14

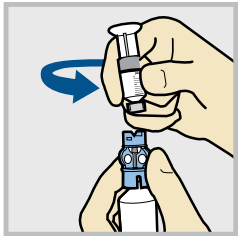

To avoid getting insulin on the top of the reservoir, **flip the vial over again so the reservoir is on top.** Hold the transfer guard and turn the reservoir counter-clockwise and remove the reservoir from the transfer guard.

WARNING: Do not use the reservoir or infusion set if insulin or any liquid gets on the top of the reservoir or inside the tubing connector, as shown in the image. If insulin, or any other liquid, gets inside the tubing connector, it can temporarily block the vents that allow the pump to properly fill the infusion set. This may result in the infusion of too little or too much insulin, and may result in hyperglycemia or hypoglycemia. If this occurs, start over with a new reservoir and infusion set.

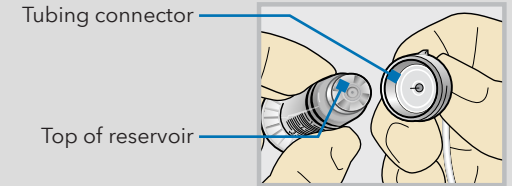

Connect the infusion set to the reservoir

15

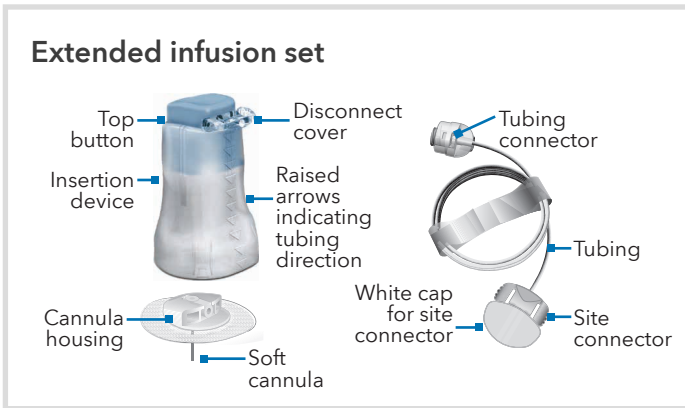

Remove infusion set from package. Remove the paper that holds the tubing together and unwind.

16

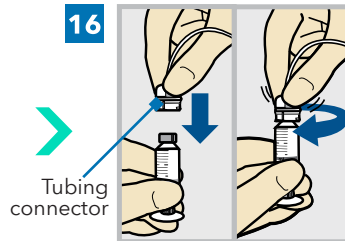

Gently push the tubing connector onto the reservoir.
Turn the connector clockwise until it is locked into place.

17

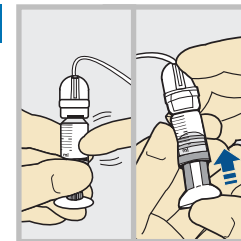

Tap the reservoir to move any air bubbles to the top. Push the plunger slightly to move the bubbles into the tubing.

18

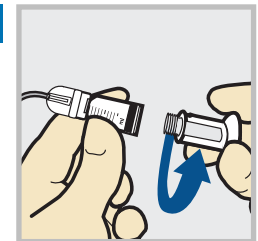

Twist the plunger counter-clockwise to loosen it and to remove it.



Place the reservoir into the pump

Note: The backlight may have turned off. Press any button to turn the screen back on. Press to go to the menu screen, and then select .

19 New Reservoir & Set

1. Fill new reservoir.
2. Connect new tubing to reservoir.

DO NOT CONNECT TO BODY.

Next

Select **Next**.



20 New Reservoir & Set

3. Place reservoir into pump and lock.

DO NOT CONNECT TO BODY.

Next

Place the reservoir into the pump. **Do not** connect the infusion set to the body.

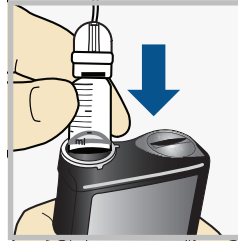

WARNING: Always confirm that the infusion set is disconnected from the body before placing the reservoir into the pump. Failing to disconnect the infusion set from the body may result in an accidental infusion of insulin, and may cause hypoglycemia.



21

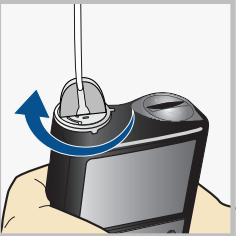

New Reservoir & Set

3. Place reservoir into pump and lock.

DO NOT CONNECT TO BODY.

Next

Turn the reservoir clockwise until the reservoir locks into place, and select **Next**.



Load the reservoir and fill the tubing

22 Load Reservoir

Select Load and hold until complete.
DO NOT CONNECT TO BODY.



Load Next

Select **Load** and hold  until the check mark appears on the screen. **Do not** connect the infusion set to the body.



23 Load Reservoir

Complete

DO NOT CONNECT TO BODY.



Load Next

When the check mark appears, select **Next**.

WARNING: Always confirm that the infusion set is disconnected from the body before loading the reservoir and filling the tubing. Failing to disconnect the infusion set from the body may result in an accidental infusion of insulin, and may cause hypoglycemia.



24 Fill Tubing

DO NOT CONNECT TO BODY.
Hold Fill until drops appear.
Then select Next.

0.0 U

Fill Next

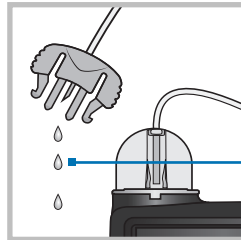
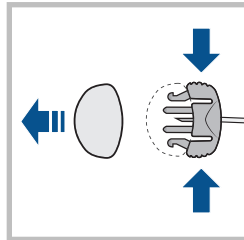

Drops at end of tubing



25 Fill Tubing

DO NOT CONNECT TO BODY.
Hold Fill until drops appear.
Then select Next.

11.3 U

Fill Next

After drops appear, press  and select **Next**.



26 Fill Cannula?

1. Insert infusion set into body.
2. Select Fill to fill cannula or Done if not needed.

Fill Done

Follow the next steps to insert the infusion set before filling the cannula.



Changing the Medtronic Extended Infusion Set with Extended Reservoir

Insert the infusion set

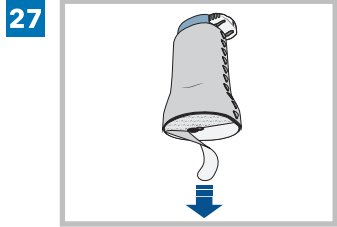

Remove the paper backing from the adhesive. Be careful not to touch the adhesive.

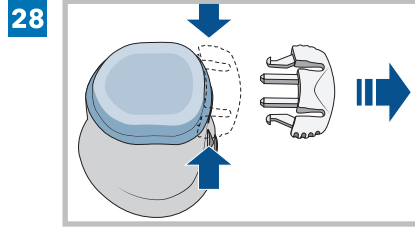

Remove the disconnect cover from the insertion device by gently squeezing the sides of the disconnect cover then pulling it away from the insertion device. Keep the disconnect cover for later use.

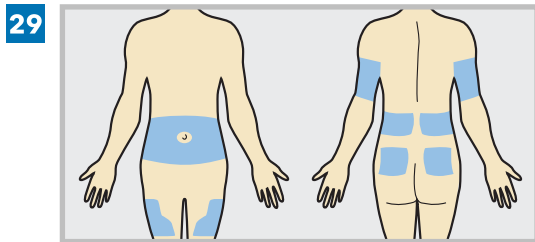

Choose an insertion site from the shaded areas. Clean the insertion site with alcohol or other antiseptic as directed by a healthcare professional.

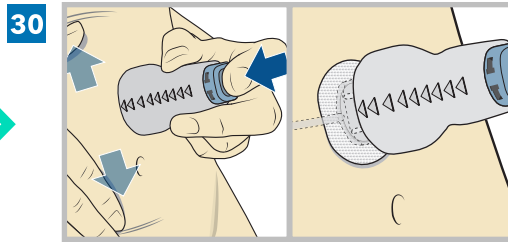

Stretch the skin until smooth. Place the insertion device in the desired location on your skin. The raised arrows indicate the direction to connect the tubing. Press the top button completely down to insert the infusion set.

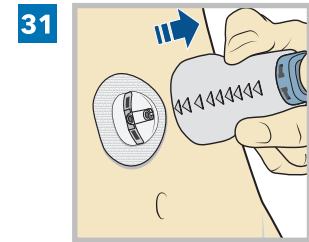

Gently and carefully remove the insertion device by pulling straight away from your body.

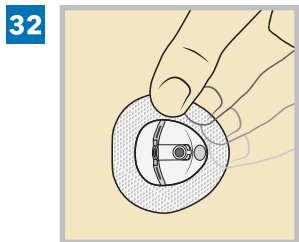

Press the adhesive onto the skin with your finger. Replace the infusion set if the adhesive does not stick to the skin

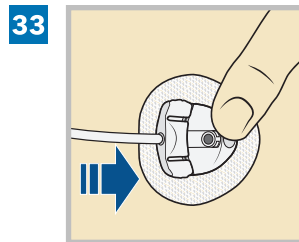

Gently hold the cannula housing steady with your finger. Then push the site connector straight into the cannula housing until you hear a click.

Note: Remove the transfer guard from the vial and dispose of the transfer guard in an appropriate sharps container and in accordance with local laws.



Fill the cannula

34 Fill Cannula?

1. Insert infusion set into body.
2. Select Fill to fill cannula or Done if not needed.

Fill Done

After the infusion set is inserted into the body, select **Fill**.

Note: Always verify that the amount shown in the **Fill amount** field is correct. The pump will remember the fill amount last used. Change the **Fill amount** if needed.



35 Fill Cannula

1. Verify Fill amount.
2. Select Fill Now when ready. Select Back to cancel.

Fill amount --- u

Fill Now

Select **Fill amount** and enter:

- 0.600 if using the 6 mm or 9 mm cannula.

After entering the cannula fill amount, press



36 Fill Cannula

1. Verify Fill amount.
2. Select Fill Now when ready. Select Back to cancel.

Fill amount 0.600 u

Fill Now

Select **Fill Now**.

The Home screen displays the insulin amount as insulin fills the cannula.



37

Delivery Resumed Successfully

The reservoir and infusion set change is now complete.

Always check blood glucose one to three hours after changing the infusion set or reservoir.



Disconnecting the infusion set from your body

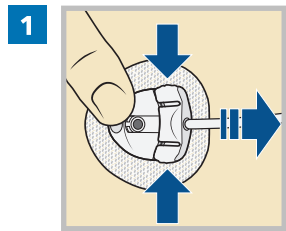

1 To disconnect, gently hold the cannula housing steady with your finger. Then squeeze the sides of the site connector and pull it out from the cannula housing.

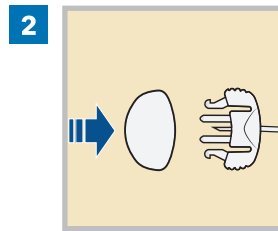

2 Put the white cap on the site connector.

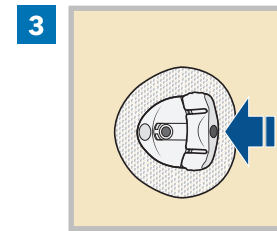

3 Put the disconnect cover on the cannula housing. Then push the cover into the cannula housing until you hear a click.

Reconnecting the infusion set to your body

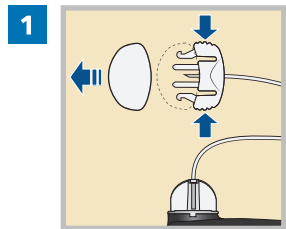

1 Remove the white cap from the site connector by squeezing the side of the site connector then pulling the white cap off.



2 Ensure there is no air in the tubing. **ONLY** if there is air in the tubing: Fill the tubing with insulin and watch for drops as instructed. Do not leave any air in the tubing.

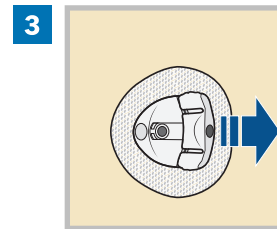

3 Remove the disconnect cover by squeezing the sides and pulling away from the cannula housing.

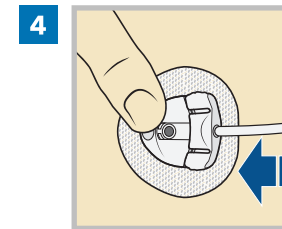

4 Use your finger to gently hold the cannula housing steady. Push the site connector into the cannula housing until you hear a click.



MiniMed 780G system | Changing the Medtronic Extended Reservoir Only



The Extended reservoir can be used for up to seven days. If the reservoir runs out of insulin and the infusion set has not been used for seven full days, the New Reservoir Only option may be used to change the reservoir. The infusion set must still be replaced within seven days of use.



MiniMed 780G system | Changing the Medtronic Extended Reservoir Only

Follow these steps to change the reservoir and keep the current infusion set.



1 Wash hands with soap and water. On the pump, press to go to the menu screen.



2 Select and then select **New Reservoir Only**.

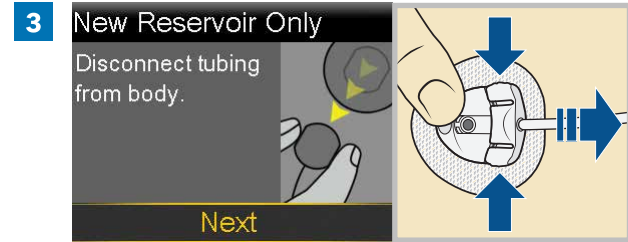

3 Disconnect the tubing from the cannula housing. Do not remove the cannula housing from the body. Select **Next**.

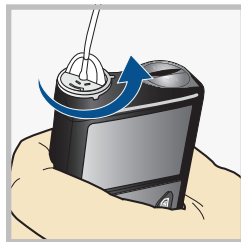
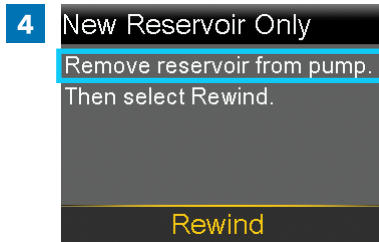

4 Remove the used reservoir from the pump.

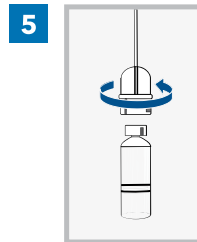

5 Disconnect the infusion set tubing connector from the used reservoir. Place the tubing on a clean surface. Do not throw the tubing away.

Note: Dispose of the used reservoir in an appropriate container and in accordance with local laws.



6 Select **Rewind**.
Do not connect the infusion set to the body.

WARNING: Always confirm that the infusion set is disconnected from the body before rewinding the pump. Failing to disconnect the infusion set from the body may result in an accidental infusion of insulin, and may cause hypoglycemia.

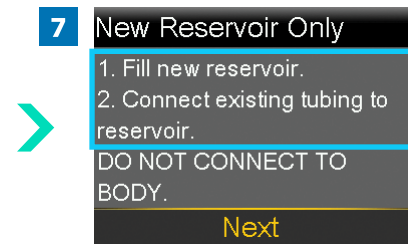

7 Follow the next steps to fill the new reservoir with insulin and to connect the new infusion set tubing. Do not select **Next**.



Fill the reservoir

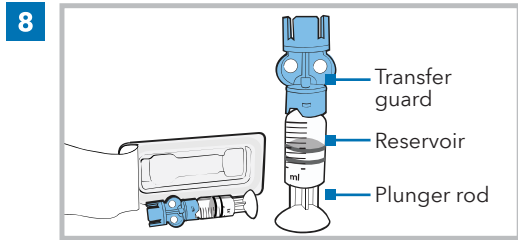

Remove the reservoir from the package. Make sure the insulin vial is at room temperature to reduce the risk of air bubbles.

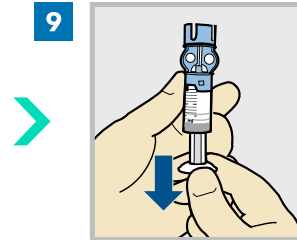

Pull the plunger down to the amount of insulin needed.

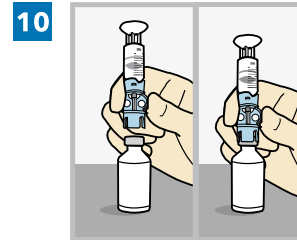

Wipe the top of the vial with isopropyl alcohol. Place the vial on a sturdy, flat surface. Firmly press the transfer guard onto the vial.

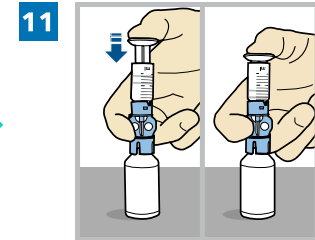

Push and hold the plunger down.

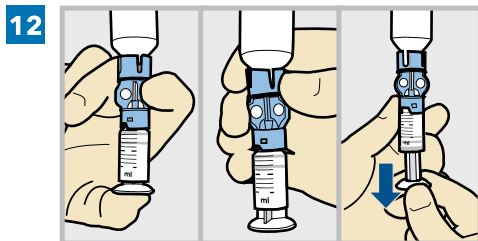

Keeping a thumb on the plunger, flip the vial over so the vial is on top. Release the thumb and pull the plunger down to fill the reservoir with insulin.

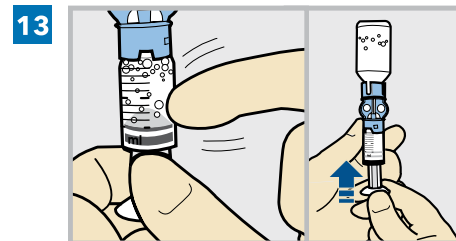

Tap the reservoir to move air bubbles to the top of the reservoir. Push the plunger up to move air into the vial.

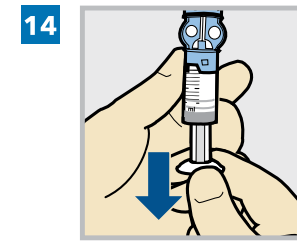

Pull the plunger back down to allow the reservoir to fill with the amount of insulin needed.

Note: The Extended infusion set and Extended reservoir can be used for up to seven days. To avoid wasting insulin, fill the reservoir with enough insulin to last until the next infusion set change.



15

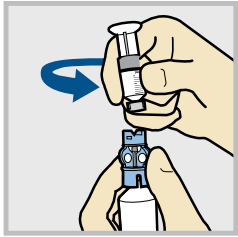

To avoid getting insulin on the top of the reservoir, **flip the vial over again so the reservoir is on top.** Hold the transfer guard and turn the reservoir counter-clockwise and remove the reservoir from the transfer guard.

WARNING: Do not use the reservoir or infusion set if insulin or any liquid gets on the top of the reservoir or inside the tubing connector, as shown in the image. If insulin, or any other liquid, gets inside the tubing connector, it can temporarily block the vents that allow the pump to properly fill the infusion set. This may result in the infusion of too little or too much insulin, and may result in hyperglycemia or hypoglycemia. If this occurs, start over with a new reservoir and infusion set.

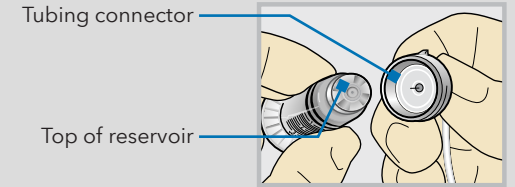

Connect the infusion set to the reservoir

16

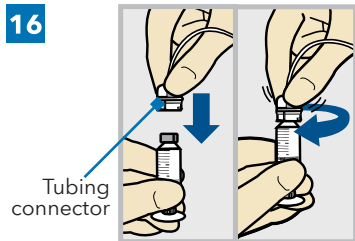

Tubing connector

Gently push the tubing connector onto the reservoir. Turn the connector clockwise until it is locked into place.



17

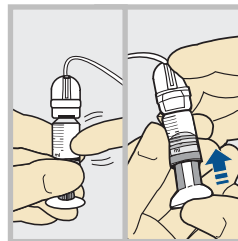

Tap the reservoir to move any air bubbles to the top. Push the plunger slightly to move the bubbles into the tubing.



18

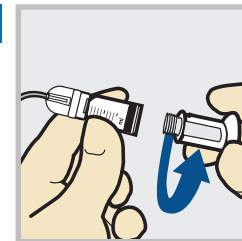

Twist the plunger counter-clockwise to loosen it and to remove it.



MiniMed 780G system | Changing the Medtronic Extended Reservoir Only

Place the reservoir into the pump

Note: The backlight may have turned off. Press any button to turn the screen back on. Press to go to the menu screen, and then select .

19 New Reservoir Only

1. Fill new reservoir.
2. Connect existing tubing to reservoir.

DO NOT CONNECT TO BODY.

Next

Select **Next**.



20 New Reservoir Only

3. Place reservoir into pump and lock.

DO NOT CONNECT TO BODY.

Next

Place the reservoir into the pump. **Do not** connect the infusion set to the body.

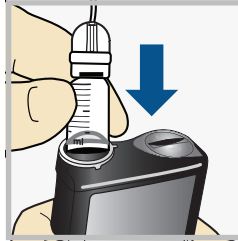

WARNING: Always confirm that the infusion set is disconnected from the body before placing the reservoir into the pump. Failing to disconnect the infusion set from the body may result in an accidental infusion of insulin, and may cause hypoglycemia.



21

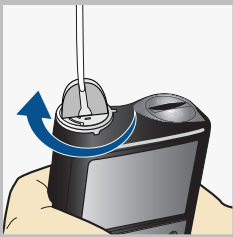

New Reservoir Only

3. Place reservoir into pump and lock.

DO NOT CONNECT TO BODY.

Next

Turn the reservoir clockwise until the reservoir locks into place, and select **Next**.



Load the reservoir and fill the tubing

22 Load Reservoir

Select Load and hold until complete.
DO NOT CONNECT TO BODY.



Load Next

Select **Load** and hold  until the check mark appears on the screen. **Do not** connect the infusion set to the body.



23 Load Reservoir

Complete

DO NOT CONNECT TO BODY.



Load Next

When the check mark appears, select **Next**.



WARNING: Always confirm that the infusion set is disconnected from the body before loading the reservoir and filling the tubing. Failing to disconnect the infusion set from the body may result in an accidental infusion of insulin, and may cause hypoglycemia.

24 Fill Tubing

DO NOT CONNECT TO BODY.
Hold Fill until drops appear.
Then select Next.

0.0_U

Fill Next

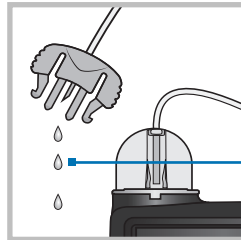
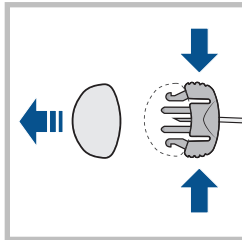

Drops at end of tubing



25 Fill Tubing

DO NOT CONNECT TO BODY.
Hold Fill until drops appear.
Then select Next.

1.3_U

Fill Next

After drops appear, press  and select **Next**.

Select **Fill** and keep holding  until there are no air bubbles visible in the tubing, and there are drops at the end of the tubing.

Do not connect the infusion set to the body.



MiniMed 780G system | Changing the Medtronic Extended Reservoir Only

Reconnect the tubing to the infusion site

26 Reconnect Tubing

Connect tubing to the infusion set. Then select Done.

Done

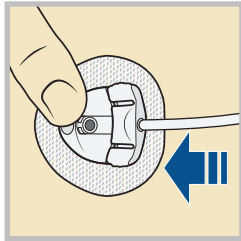

Use your finger to gently hold the cannula housing steady. Push the site connector into the cannula housing until you hear a click.

27 Reconnect Tubing

Connect tubing to the infusion set. Then select Done.

Done

It is not necessary to fill the cannula because the infusion set was not changed. Select **Done**.



The reservoir change is now complete.

Always check blood glucose one to three hours after changing the reservoir.

Note: Remove the transfer guard from the vial and dispose of the transfer guard in an appropriate sharps container and in accordance with local laws.



The Extended infusion set can be used for up to seven days. If only the infusion set needs to be changed before seven full days of use, the New Set Only option may be used to change the infusion set. The reservoir must still be replaced within seven days of use.



MiniMed 780G system | Changing the Medtronic Extended Infusion Set Only

Follow these steps to change the infusion set and to keep the current reservoir.



1 Wash hands with soap and water. On the pump, press to go to the menu screen.



2 Select , and then select **New Set Only**.



3 Remove the entire infusion set by loosening the adhesive and pulling the set away from the body. Select **Next**.

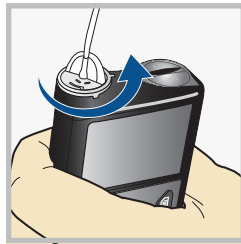

4 Remove the used reservoir from the pump.



5 Select **Rewind**.
Do not connect the infusion set to the body.

WARNING: Always confirm that the infusion set is disconnected from the body before rewinding the pump. Failing to disconnect the infusion set from the body may result in an accidental infusion of insulin, and may cause hypoglycemia.

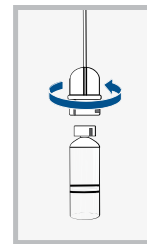
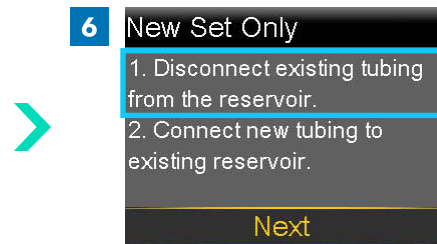

6 Disconnect the infusion set tubing connector from the reservoir and throw away the used infusion set. Place the current reservoir on a clean surface. Do not throw away.

Note: Dispose of all parts of the infusion set, including the tubing, in an appropriate sharps container and in accordance with local laws.



Connect the infusion set to the reservoir

7 New Set Only

1. Disconnect existing tubing from the reservoir.
2. Connect new tubing to existing reservoir.

Next

Follow these steps to connect the infusion set to the reservoir.

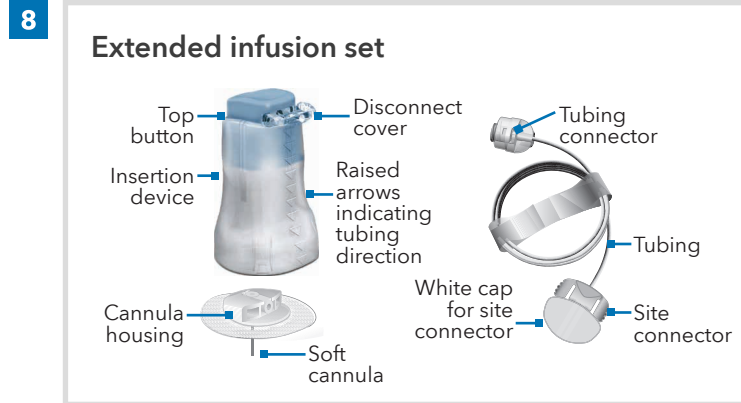

Remove infusion set from package. Remove the paper that holds the tubing together and unwind.

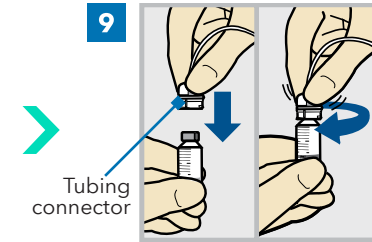

Gently push the tubing connector onto the reservoir.

Turn the connector clockwise until it is locked into place.

WARNING: Do not use the reservoir or infusion set if insulin or any liquid gets on the top of the reservoir or inside the tubing connector, as shown in the image. If insulin, or any other liquid, gets inside the tubing connector, it can temporarily block the vents that allow the pump to properly fill the infusion set. This may result in the infusion of too little or too much insulin, and may result in hyperglycemia or hypoglycemia. If this occurs, start over with a new reservoir and infusion set.

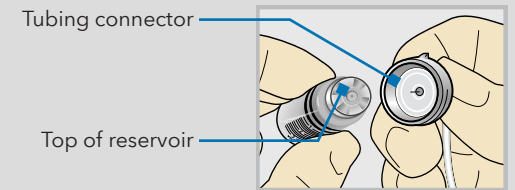



MiniMed 780G system | Changing the Medtronic Extended Infusion Set Only

Place the reservoir into the pump

10 New Set Only

1. Disconnect existing tubing from the reservoir.
2. Connect new tubing to existing reservoir.

Next

Select **Next**.



11 New Set Only

3. Place reservoir into pump and lock.

DO NOT CONNECT TO BODY.

Next

Place the reservoir into the pump. **Do not** connect the infusion set to the body.

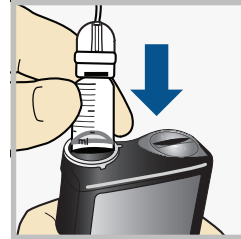

WARNING: Always confirm that the infusion set is disconnected from the body before placing the reservoir into the pump. Failing to disconnect the infusion set from the body may result in an accidental infusion of insulin, and may cause hypoglycemia.



12

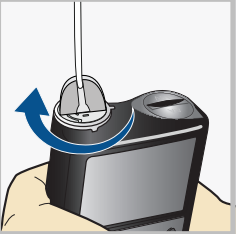

New Set Only

3. Place reservoir into pump and lock.

DO NOT CONNECT TO BODY.

Next

Turn the reservoir clockwise until the reservoir locks into place, and select **Next**.



Load the reservoir and fill the tubing

13 Load Reservoir

Select Load and hold until complete.
DO NOT CONNECT TO BODY.



Load Next

Select **Load** and hold  until the check mark appears on the screen. **Do not** connect the infusion set to the body.



14 Load Reservoir

Complete

DO NOT CONNECT TO BODY.



Load Next

When the check mark appears, select **Next**.

WARNING: Always confirm that the infusion set is disconnected from the body before loading the reservoir and filling the tubing. Failing to disconnect the infusion set from the body may result in an accidental infusion of insulin, and may cause hypoglycemia.



15 Fill Tubing

DO NOT CONNECT TO BODY.
Hold Fill until drops appear.
Then select Next.

0.0_U

Fill Next

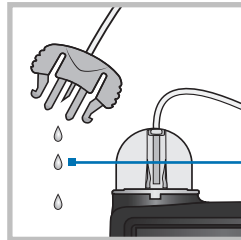
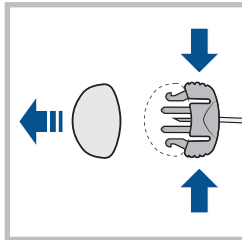

Drops at end of tubing



16 Fill Tubing

DO NOT CONNECT TO BODY.
Hold Fill until drops appear.
Then select Next.

11.3_U

Fill Next

After drops appear, press  and select **Next**.



17 Fill Cannula?

1. Insert infusion set into body.
2. Select Fill to fill cannula or Done if not needed.

Fill Done

Follow the next steps to insert the infusion set before filling the cannula.



Insert the infusion set

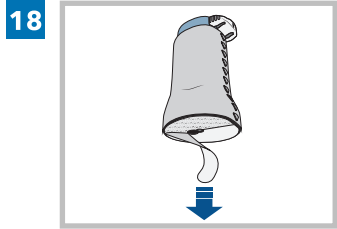

Remove the paper backing from the adhesive. Be careful not to touch the adhesive.

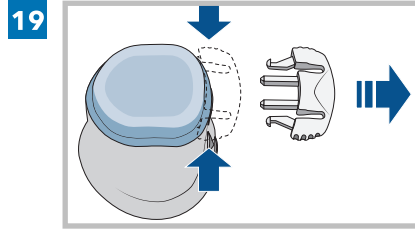

Remove the disconnect cover from the insertion device by gently squeezing the sides of the disconnect cover then pulling it away from the insertion device. Keep the disconnect cover for later use.

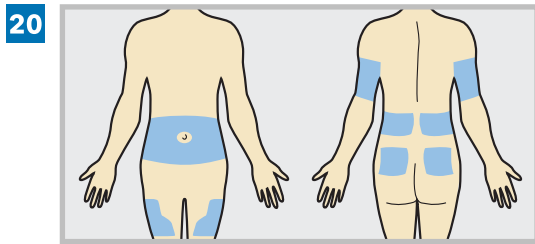

Choose an insertion site from the shaded areas. Clean the insertion site with alcohol or other antiseptic as directed by a healthcare professional.

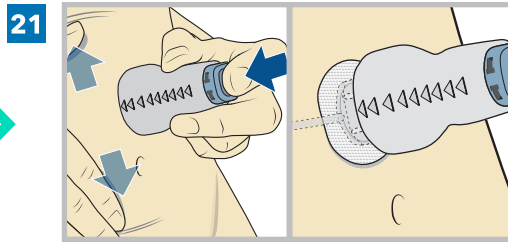

Stretch the skin until smooth. Place the insertion device in the desired location on your skin. The raised arrows indicate the direction to connect the tubing. Press the top button completely down to insert the infusion set.

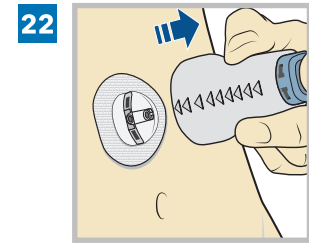

Gently and carefully remove the insertion device by pulling straight away from your body.

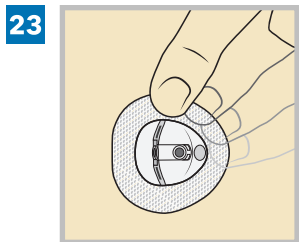

Press the adhesive onto the skin with your finger. Replace the infusion set if the adhesive does not stick to the skin

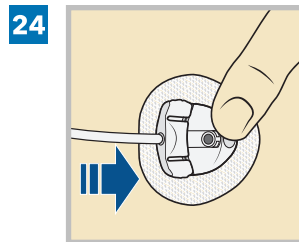

Gently hold the cannula housing steady with your finger. Then push the site connector straight into the cannula housing until you hear a click.

Note: Dispose of the insertion device in an appropriate sharps container and in accordance with your local laws.



MiniMed 780G system | Changing the Medtronic Extended Infusion Set Only

Fill the cannula

25 Fill Cannula?

1. Insert infusion set into body.
2. Select Fill to fill cannula or Done if not needed.

Fill Done

After the infusion set is inserted into the body, select **Fill**.

Note: Always verify that the amount shown in the **Fill amount** field is correct. The pump will remember the fill amount last used. Change the **Fill amount** if needed.



26 Fill Cannula

1. Verify Fill amount.
2. Select Fill Now when ready. Select Back to cancel.

Fill amount --- u

Fill Now

Select **Fill amount** and enter:
• 0.600 if using the 6 mm or 9 mm cannula.
After entering the cannula fill amount, press



27 Fill Cannula

1. Verify Fill amount.
2. Select Fill Now when ready. Select Back to cancel.

Fill amount 0.600 u

Fill Now

Select **Fill Now**.
The Home screen displays the insulin amount as insulin fills the cannula.



28

Delivery Resumed Successfully

The infusion set change is now complete.
Always check blood glucose one to three hours after changing the infusion set.



MiniMed 780G system | Inserting the Guardian™ 4 Sensor with One-press Serter





MiniMed 780G system | Inserting the Guardian™ 4 Sensor with One-press Sertter

Insert the sensor

Choose an insertion site that has an adequate amount of subcutaneous fat. The Guardian 4 sensor has been studied and is approved for use in the following sensor insertion sites by persons of the following ages:

Approved Age	Sensor Insertion Site
7 and older	Arm

CAUTION: The Guardian 4 sensor is indicated for arm use only. Do not use Guardian 4 sensor in the abdomen or other body sites including the buttocks, due to unknown or different performance that could result in hypoglycemia or hyperglycemia.

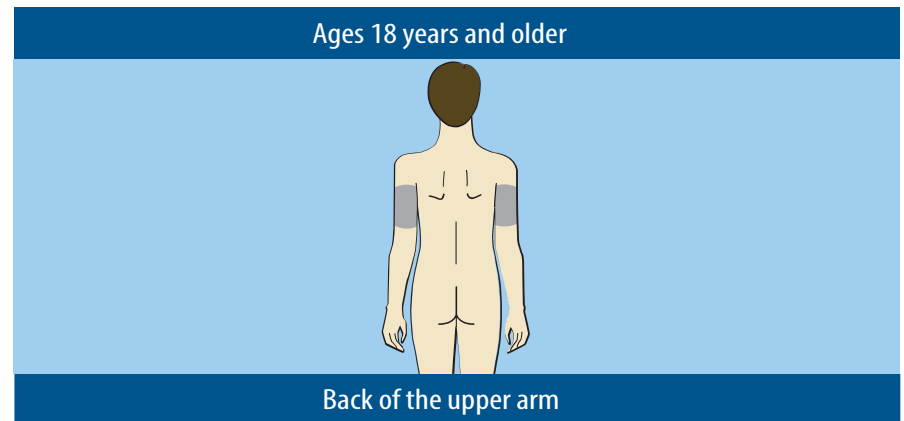
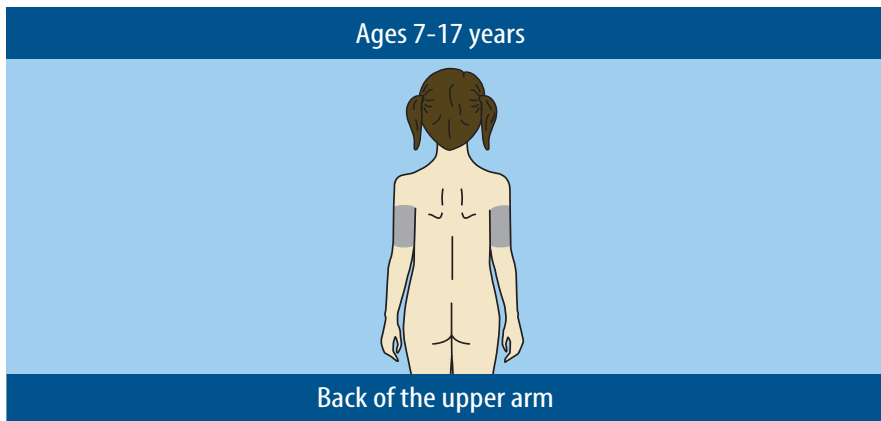

Note: Assistance will likely be needed for sensor insertion into the back of the upper arm. Some users find it difficult to insert the sensor into their arm by themselves.



MiniMed 780G system | Inserting the Guardian™ 4 Sensor with One-press Sertter

Insert a new sensor

Wash hands with soap and water and clean the insertion site with alcohol.

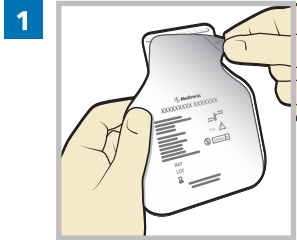

1

Open the sensor package.

Pull the corner of the paper covering to open the sensor package.

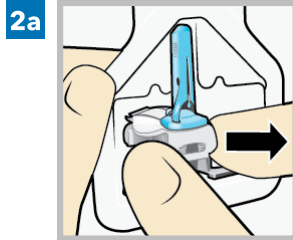

2a

Hold the sensor by the plastic pedestal.

Remove the sensor with attached pedestal from the packaging by holding the pedestal only. Place the sensor with the pedestal on a clean, flat surface (such as a table).

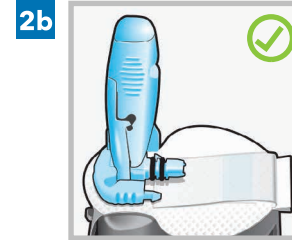

2b

Correct

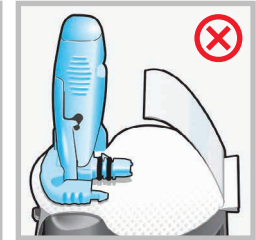

Incorrect



Tuck the adhesive tab. Make sure that the sensor's adhesive tab is tucked under the sensor connector and snaps.

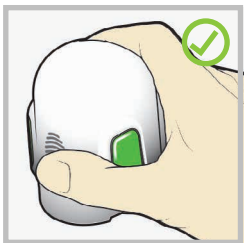

Correct



Incorrect

Note: Refer to the illustrations for correct and incorrect ways to hold the sertter for loading.

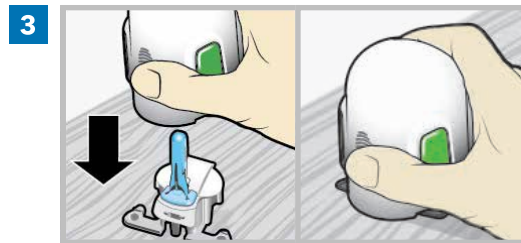

3

Load the sensor into the sertter. Grip the sertter exactly as shown **with a thumb on the thumb print on the sertter. Do not hold the side buttons.** Push the sertter down onto the pedestal until the base of the sertter sits flat on the table.



MiniMed 780G system | Inserting the Guardian™ 4 Sensor with One-press Sertter

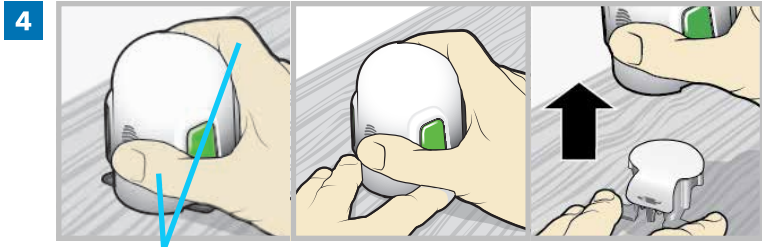

Fingers are NOT holding the side buttons.

Detach the sertter from the pedestal. To detach the sertter from the pedestal, grip the sertter as shown with a thumb on the thumb print on the sertter. With the other hand, place two fingers on the pedestal arms, and slowly pull the sertter straight up.

Note: Make sure that the pedestal is firmly on the table before pulling the sertter away.

CAUTION: Do not detach the pedestal from the sertter in mid-air as this may damage the sensor.

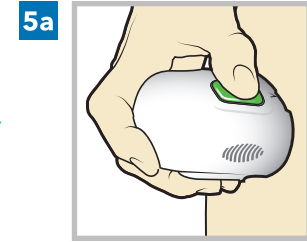

Place the sertter on the body. Hold the sertter steadily against the cleaned insertion site without pushing the sertter too deeply into the skin.

Note: Failing to hold the sertter securely flat against the body may allow the sertter to spring back after pressing buttons and result in improper insertion of the sensor.

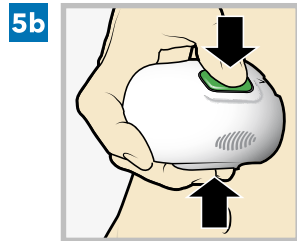

Insert the sensor. Press the **bump** on both buttons and release them at the same time.

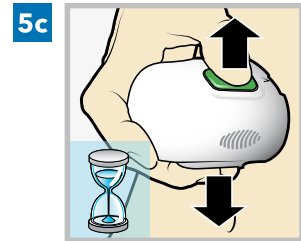

Hold the sertter against the body. Continue holding the sertter against the body for at least five seconds to allow the adhesive to stick to the skin.

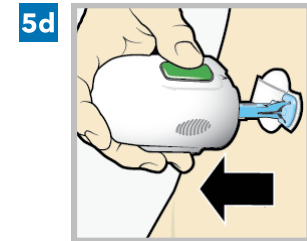

Remove the sertter from body. Slowly pull the sertter away from the skin, making sure the buttons are not pressed.



MiniMed 780G system | Inserting the Guardian™ 4 Sensor with One-press Sertter

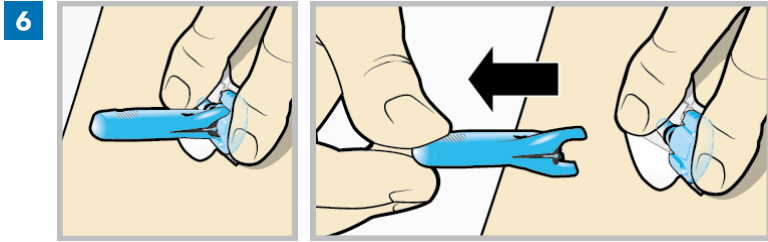

6 **Remove the needle housing.** Gently hold the base of the sensor against the skin with one hand. With the other hand, hold the needle housing **at the top** and slowly pull it straight away from the sensor. Dispose of the needle housing in a sharps container.

Note: An optional, liquid adhesive, such as Skin Tac™, may be used on the skin. Apply the adhesive and allow the skin to dry before removing the adhesive pad liner.

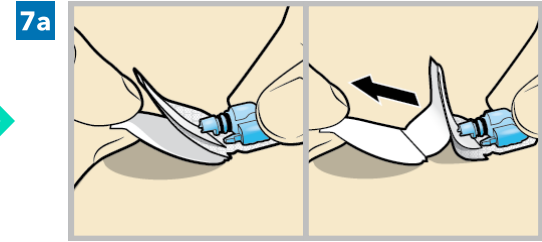

7a **Remove the adhesive pad liner.** Hold the sensor in place and gently remove the liner from under the adhesive pad.

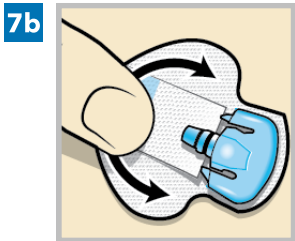

7b **Press the entire adhesive pad to the skin.** Firmly press the adhesive pad against the skin and smooth the entire adhesive pad so it sticks to the skin.

Note: The sensor adhesive is sensitive to pressure. Continue applying pressure on the adhesive to ensure that the sensor remains inserted in the skin for 7 days of wear.

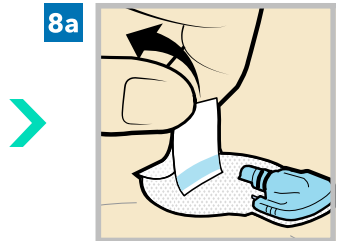

8a **Untuck the adhesive tab.** Untuck the adhesive tab from under the sensor connector.

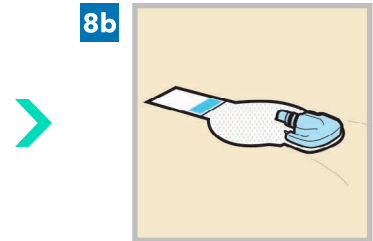

8b **Straighten the adhesive tab.** Straighten the adhesive tab so it lies flat against the skin, but do not remove the adhesive liner yet.



MiniMed 780G system | Inserting the Guardian™ 4 Sensor with One-press Sertter

Tape the sensor

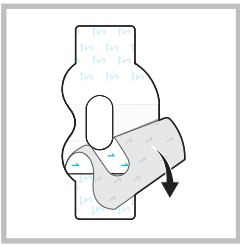
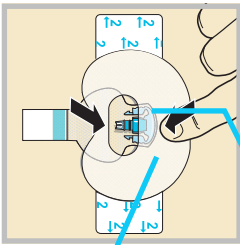
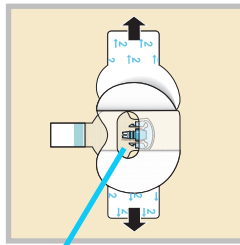
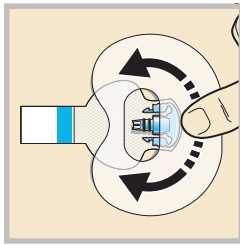
- 9** 
Remove the liner marked 1.
- 10** 
Wide part of tape covers half of sensor base.
Both sensor and skin are taped.
Apply the tape as shown and press down firmly.
- 11** 
Connector and snaps in hole of tape.
Remove the liner marked 2 from each side.
- 12** 
Smooth the tape.

Connect the transmitter

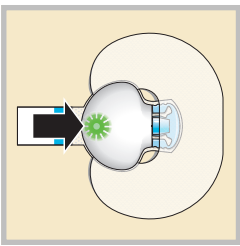
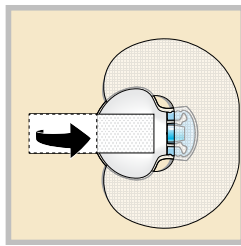
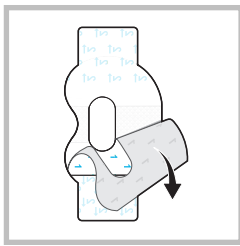
- 13** 
Connect the transmitter to the sensor.
Note: Wait for the green light on the transmitter to flash. If the green light does not flash, refer to Troubleshooting section of the transmitter user guide.
- 14** 
Cover the transmitter with the adhesive tab.
Note: Do not pull the tab too tightly.
- 15** 
To apply the 2nd tape, remove the liner marked 1.



MiniMed 780G system | Inserting the Guardian™ 4 Sensor with One-press Senter

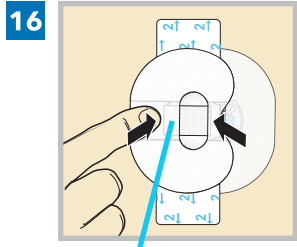

Wide part of tape covers end of transmitter and skin.

Rotate the 2nd tape and place the tape over the transmitter. Press down firmly.

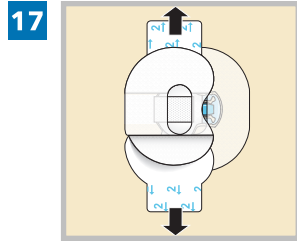

Remove the liner marked 2 from each side.

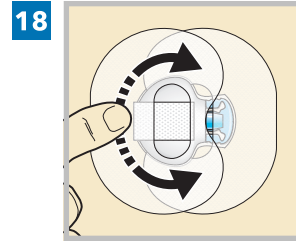

Smooth the tape.

Note: Check the site regularly. Apply additional off-the-shelf tape if the sensor and the transmitter are not secure.

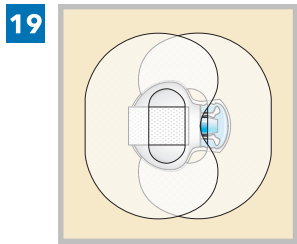

This image is an example of the tape applied correctly.

Connect the transmitter

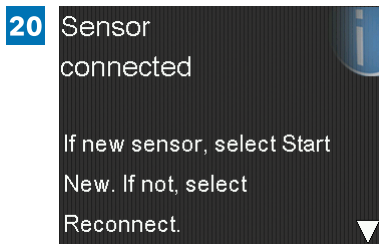

After **Sensor connected** message appears, press . The message typically takes less than a minute to appear, but may take up to 5 minutes.

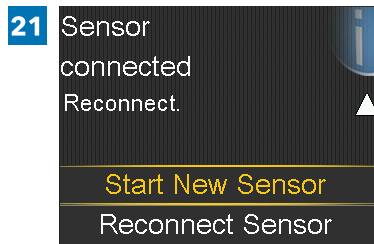

Select **Start New Sensor**.

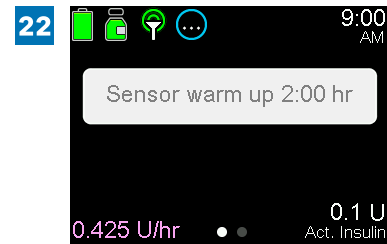

Sensor warm up X:XX hr will appear on the Home screen. After the warm up is complete, the pump begins receiving SG readings.

R_x *Only*

M048911C001_1